



Education and Culture DG

Lifelong Learning Programme



eTwinning

# EASTER ACTIVITIES

## 2013



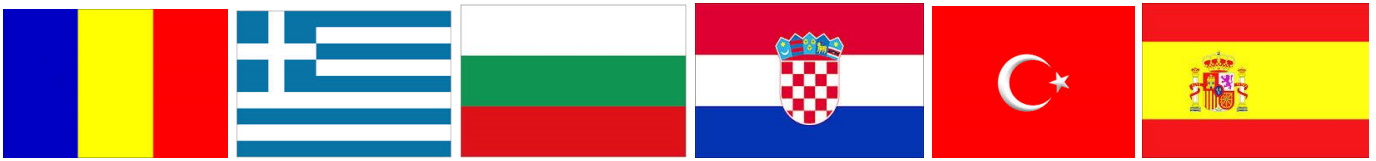

# Contents



<b>Part III - Easter Fun Activities</b> .....	<b>3</b>
<b>Easter Crosswords</b> .....	<b>4 - 14</b>
<b>Easter Wordsearch</b> .....	<b>5 - 29</b>
<b>Easter Sudocu</b> .....	<b>30 - 37</b>
<b>Let's Play Math!</b> .....	<b>38 - 74</b>
<b>Easter Maze</b> .....	<b>75- 82</b>
<b>Easter Wishes in Different Languages</b> .....	<b>83</b>



# Part III

## Easter Fun Activities



# Easter Crossword

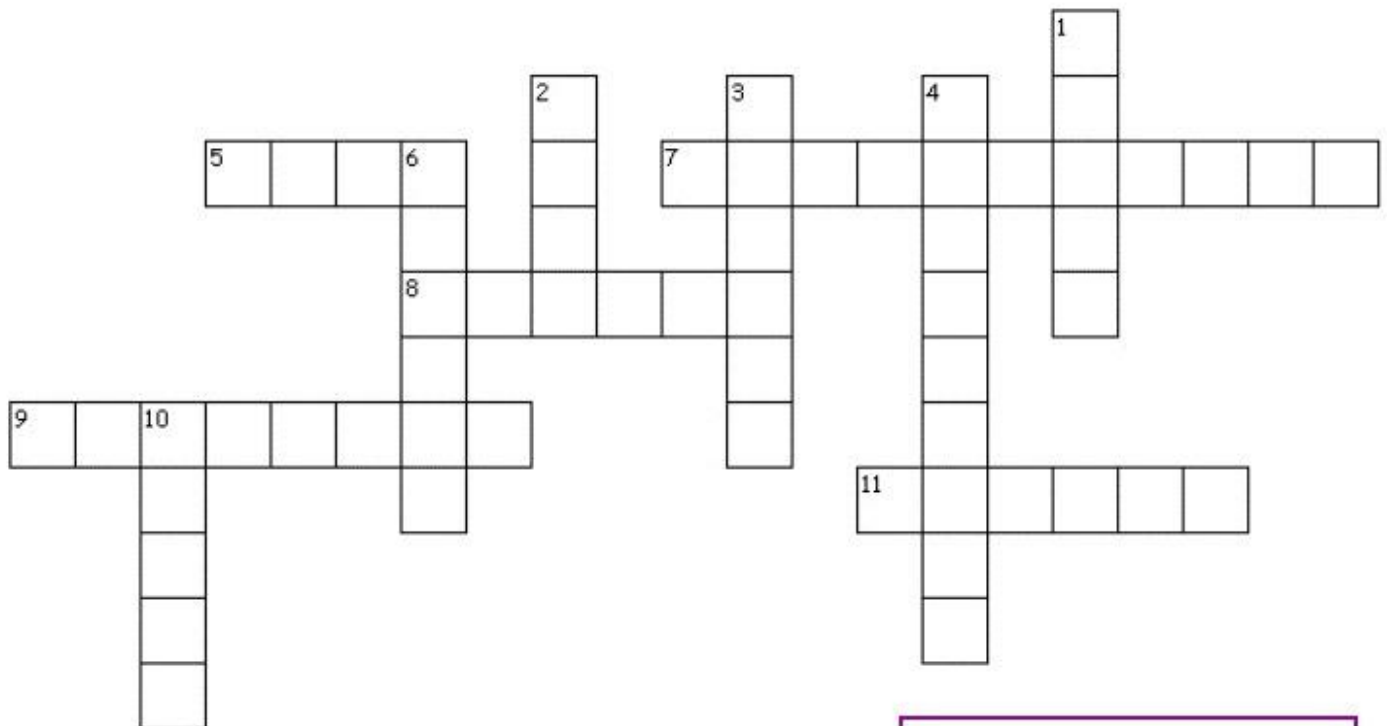

## Word List:

basket, chick, chocolate, crack, duckling, eggs, lamb, marshmallow, pastel, rabbit, spring

### Across

5. Which came first? The chickens or the \_\_\_\_\_?
7. ooey, gooey goodness
8. Animal that brings treats and eats carrots.
9. baby duck
11. Container for collecting eggs at Easter.

### Down

1. If you drop an Easter egg, it will \_\_\_\_\_.
2. baby sheep
3. Pale, light colors.
4. Tasty, decadent treat.
6. Easter's season
10. baby chicken

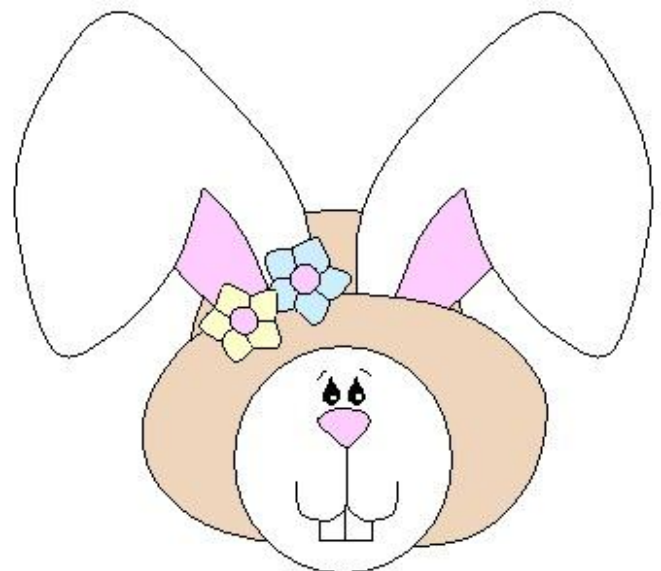

# Easter Crossword

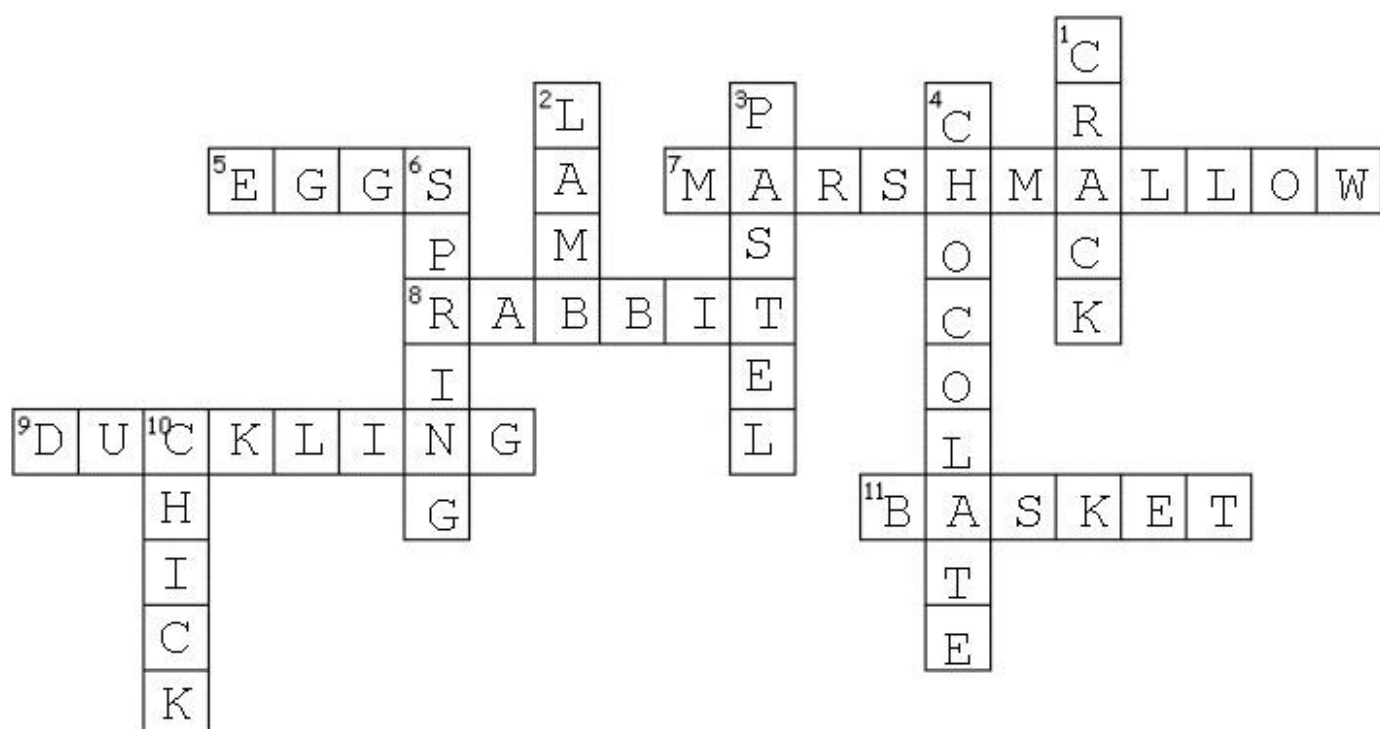

## Across

- Which came first? The chickens or the \_\_\_\_\_?
- ooey, gooey goodness
- Animal that brings treats and eats carrots.
- baby duck
- Container for collecting eggs at Easter.

## Down

- If you drop an Easter egg, it will \_\_\_\_\_.
- baby sheep
- Pale, light colors.
- Tasty, decadent treat.
- Easter's season
- baby chicken

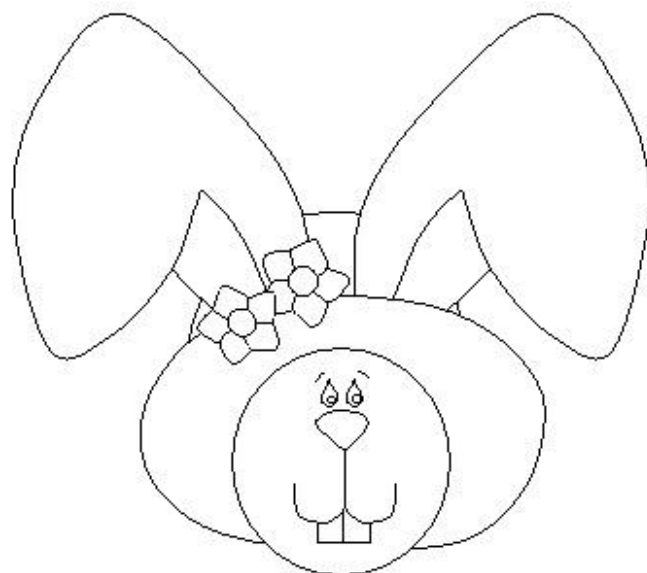

# Easter Crossword

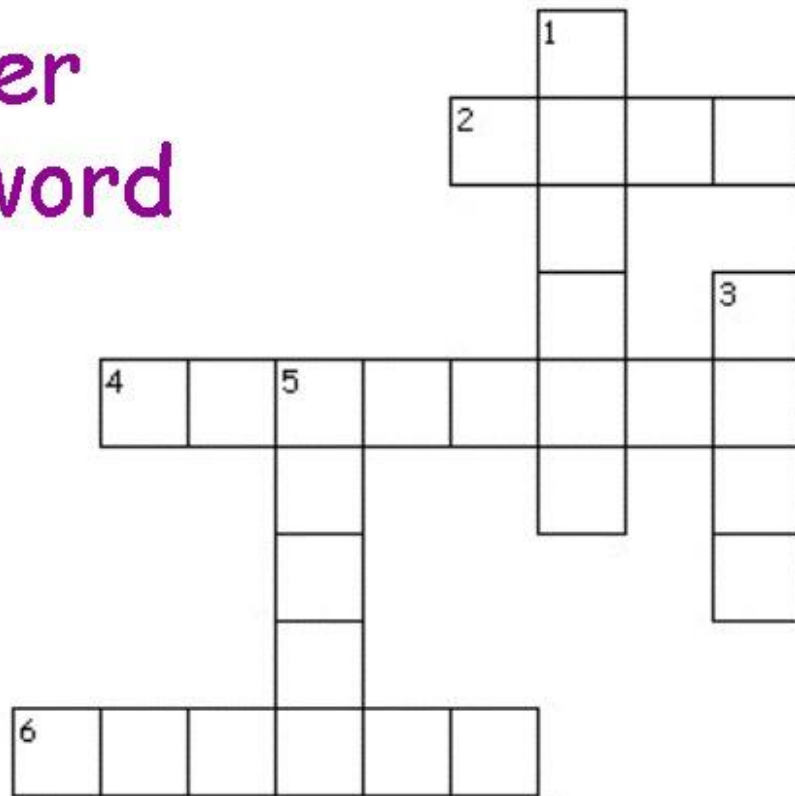

## Across

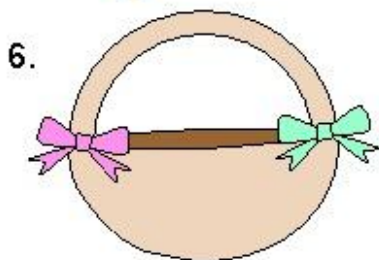
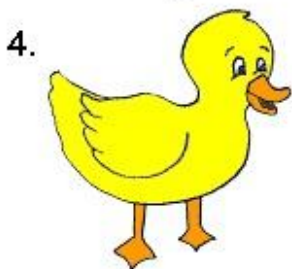
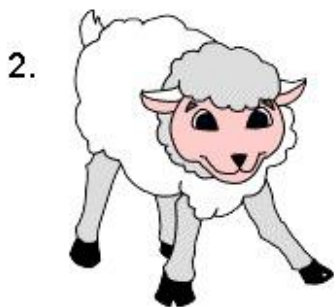

## Down

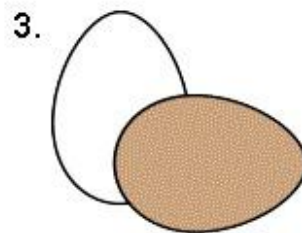



# Easter Crossword

**Word List:**

basket, chick,  
duckling, eggs,  
lamb, rabbit

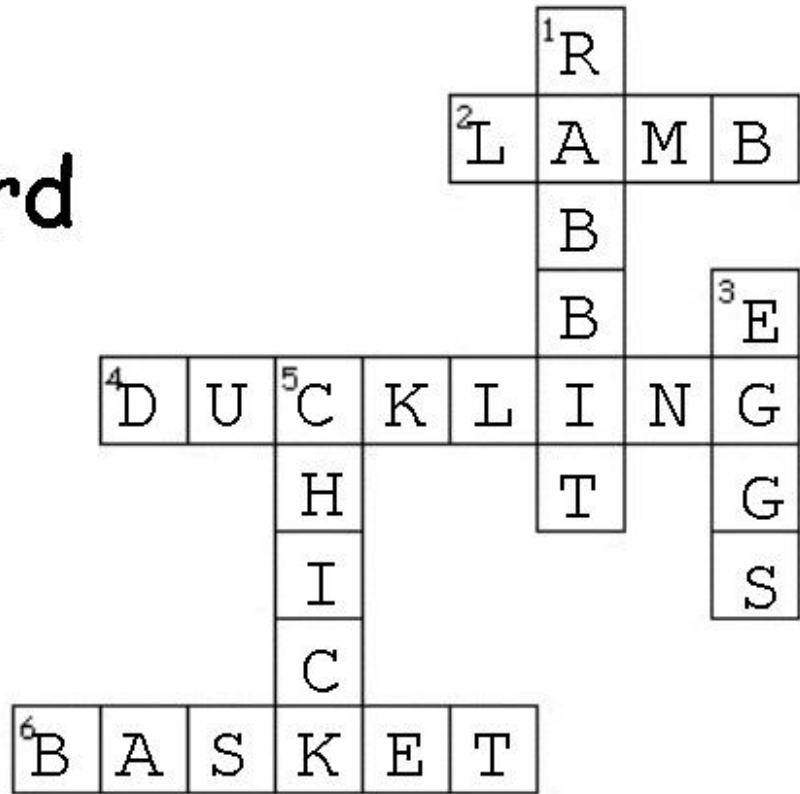

**Across**

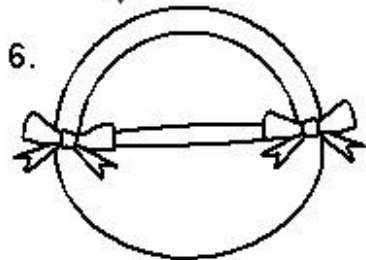
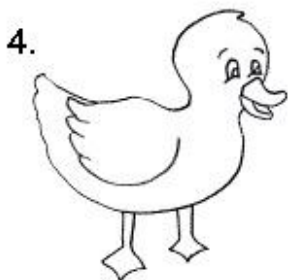
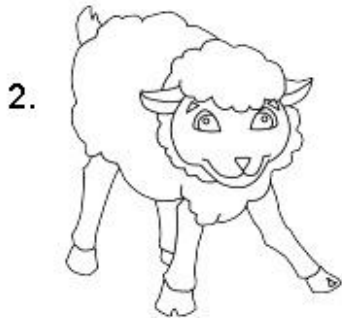

**Down**

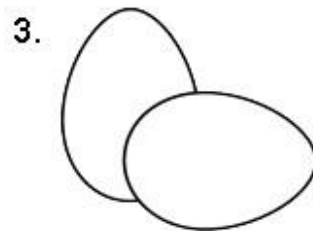
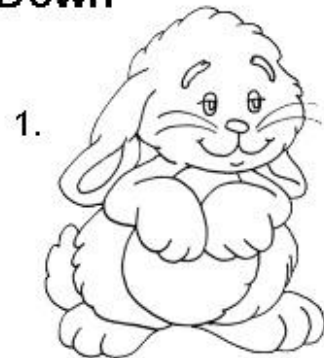





# Easter Crossword

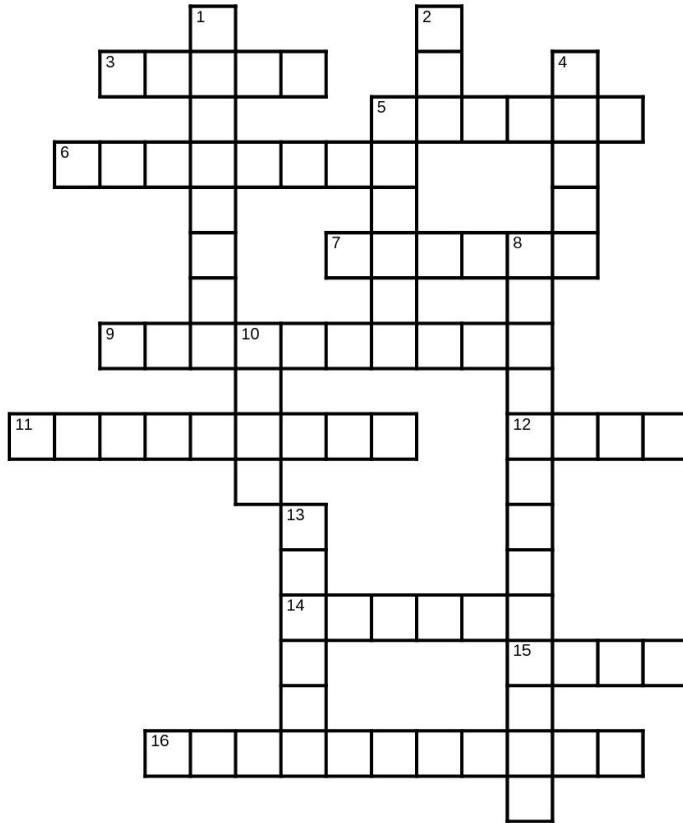

Fill in the crossword using the clues below:

**Across**

- 3. Another word for 'over'.
- 5. Another word for 'in back of'.
- 6. Make eggs look pretty.
- 7. A big meal at the end of the day.
- 9. Little egg-shaped candies.
- 11. What some bunnies are made of.
- 12. What children hunt for on Easter.
- 14. The season of Easter.
- 15. The opposite of search.
- 16. An animal that hides eggs.

**Down**

- 1. A word to describe Easter eggs.
- 2. Watery color.
- 4. Another word for 'beneath'.
- 5. Another word for 'next to'.
- 8. An activity where children find eggs and chocolate.
- 10. An Easter flower.
- 13. Something to carry Easter eggs in.



*Easter Lilies*



**Answer the following questions:**

*Have you ever decorated an Easter egg before?*

*Do you prefer white chocolate or dark chocolate?*

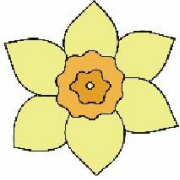

# Easter Crossword

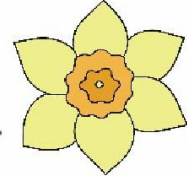

Solve the crossword using the list of words and the clues

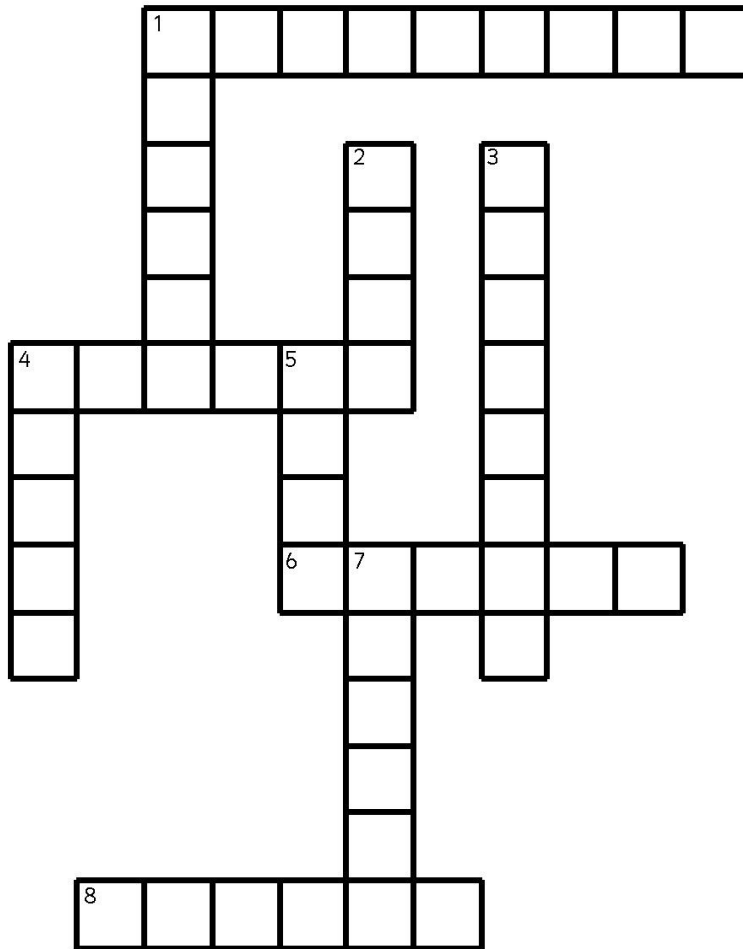

- basket
- bonnet
- bunny
- chicks
- chocolate
- daffodil
- eggs
- hunt
- parade
- spring

## Across

1. Easter eggs are often made out of this treat!
4. Collect your eggs in this.
6. The season in which Easter is celebrated.
8. You may wear one in the Easter parade.

## Down

1. These hatch out of real eggs.
2. You may go on an Easter egg ...
3. Cheerful, yellow spring flower.
4. Will he visit you this year?
5. We give chocolate ones at Easter.
7. Show off your Easter bonnet at one!

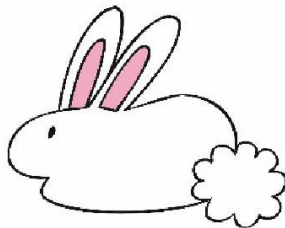

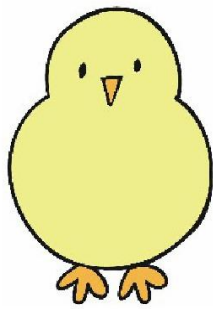

# Easter Crossword

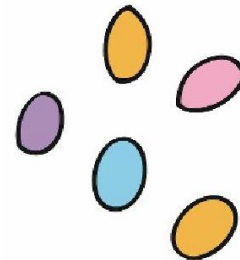
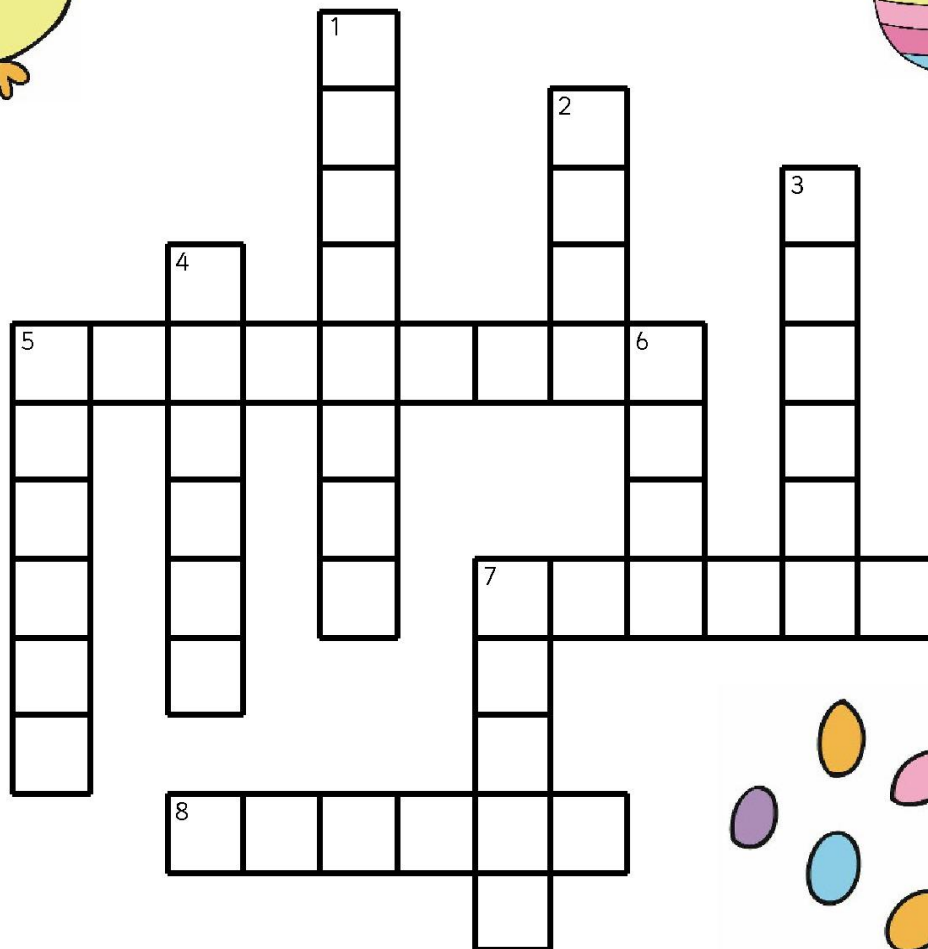

## Across

5. Easter eggs are often made out of this treat!
7. Collect your eggs in this.
8. The season in which Easter is celebrated.

## Down

1. Cheerful, yellow spring flower.
2. You may go on an Easter egg ...
3. Show off your Easter bonnet at one!
4. You may wear one in the Easter parade.
5. These hatch out of real eggs.
6. We give chocolate ones at Easter.
7. Will he visit you this year?

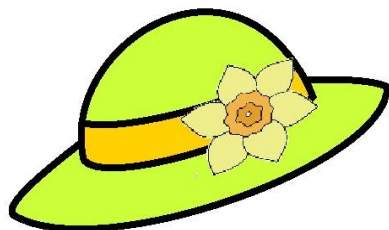

# Easter Crossword

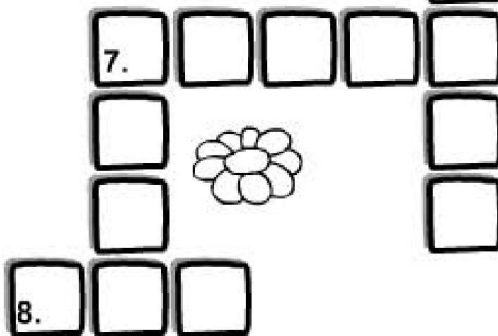
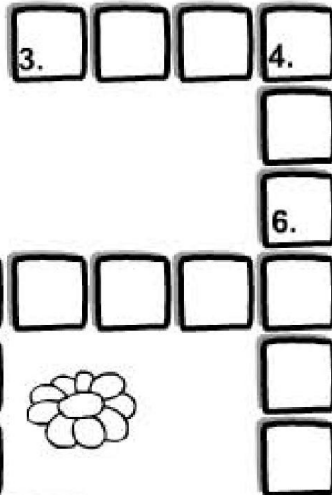
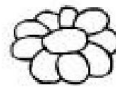
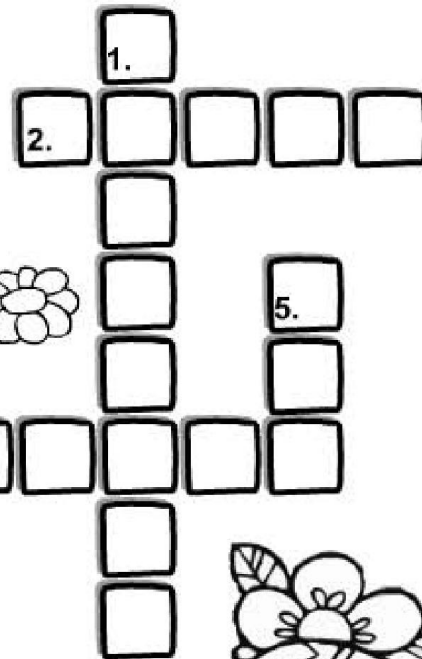

**ACROSS** →

↓ **DOWN**

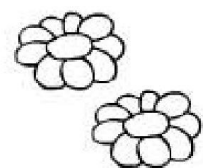
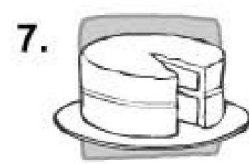
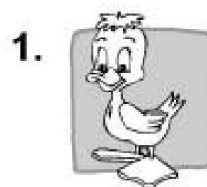

# Easter Crossword

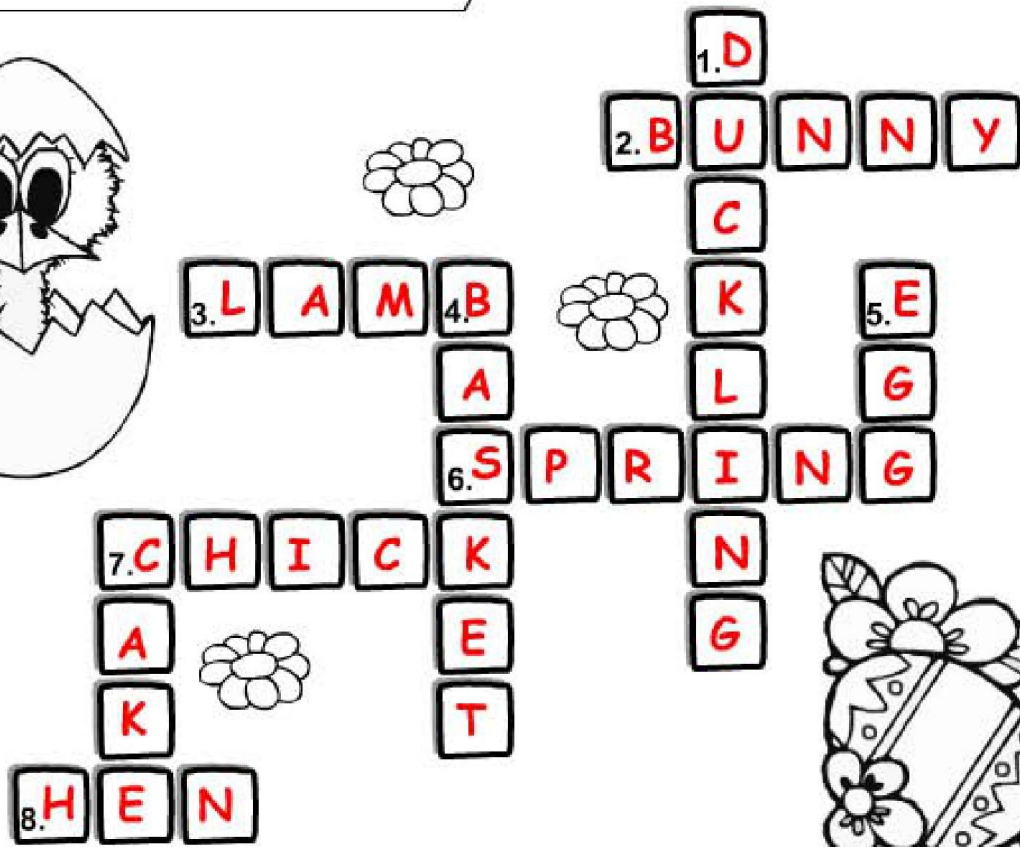

ACROSS →

↓ DOWN

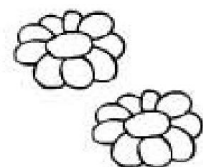
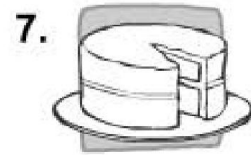
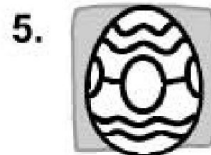
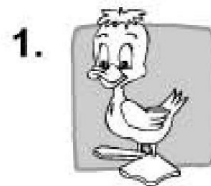

# Easter Crossword

- EGGS
- LILY
- CHICK
- BASKET
- EASTER
- FLOWERS
- DAFFODILS

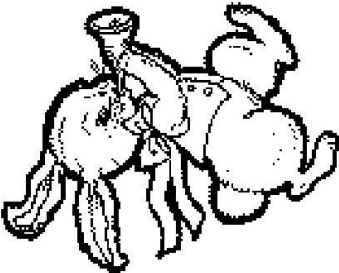

A crossword puzzle grid with a central Easter egg illustration. The grid consists of empty squares for letters, with some squares containing the egg illustration. The grid is composed of several intersecting words.

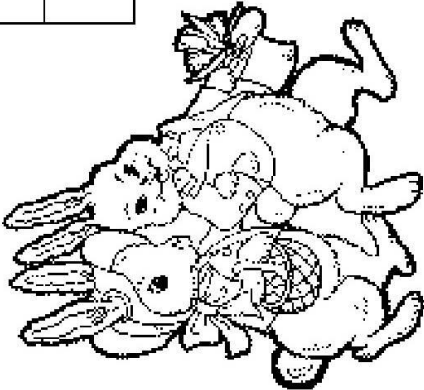

# Easter Wordsearch

www.mes-english.com

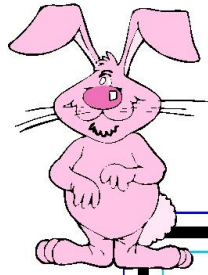

## HAPPY EASTER!



P W V Q K E B D L B H U  
A G N O F T G A S P I K  
R L A Z L A R Z S E D G  
A N I A I L Y D T K E R  
D Y M L T O E A S T E R  
E B L B Y C R E Y D H T  
Y N N U B O R P S U S S  
K K I D C H E P I G U Y  
C E O E F C R B G L X F  
I U D F J I O E F Y U I  
H G H U N T M D V R R T  
C M L G L Y D Y I A A M

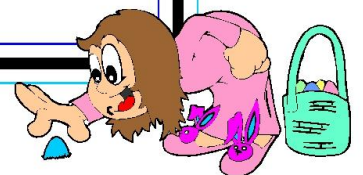

Easter

eggs

bunny

basket

chocolate

parade

spring

dye

hunt

decorate

tulip

lily

hide

lamb

chick

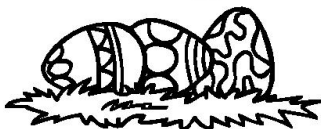

MES-English.com

Resources for Teachers

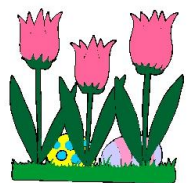

# HAPPY EASTER!

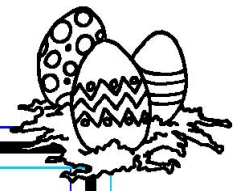
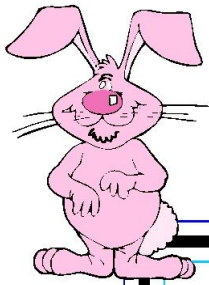

T	K	E	E	C	C	Y	C	F	R	J	E
J	U	G	M	B	H	B	H	Y	D	E	X
T	G	L	M	E	I	O	O	E	L	D	S
S	E	A	I	L	C	G	C	D	K	I	F
F	L	K	J	P	K	O	O	A	L	H	L
M	P	X	S	W	R	F	L	R	M	D	O
R	E	T	S	A	E	E	A	A	T	G	I
G	L	A	T	I	B	Z	T	P	N	G	W
H	V	E	T	N	U	H	E	I	R	B	T
B	U	N	N	Y	V	W	R	D	Y	E	C
U	F	M	H	Q	W	P	F	L	L	Y	T
N	F	Z	Z	B	S	C	Y	G	A	B	T



Easter

eggs

bunny

basket

chocolate

parade

spring

dye

hunt

decorate

tulip

lily

hide

lamb

chick

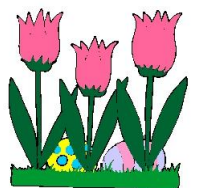
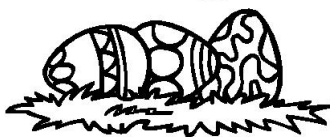



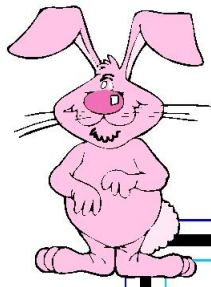

# HAPPY EASTER!

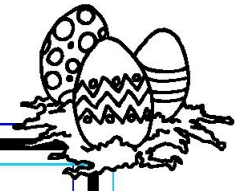

L	J	P	L	P	P	K	E	L	E	E	R
P	I	T	A	A	W	I	A	H	T	E	Q
K	W	L	E	R	J	M	L	A	Y	K	G
C	H	E	Y	A	B	B	R	U	G	B	V
I	I	T	V	D	B	O	A	F	T	B	P
H	D	A	V	E	C	E	A	S	T	E	R
C	E	L	Z	E	R	S	P	Z	K	H	B
M	V	O	D	Y	G	R	Q	G	H	E	L
S	O	C	Z	G	I	Y	N	N	U	B	T
A	I	O	E	N	Z	H	U	N	T	I	M
W	R	H	G	E	E	Y	D	E	E	A	W
J	E	C	M	D	U	M	Z	Q	N	S	F



Easter

eggs

bunny

basket

chocolate

parade

spring

dye

hunt

decorate

tulip

lily

hide

lamb

chick

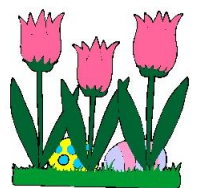
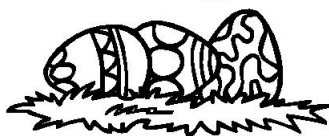

# HAPPY EASTER!

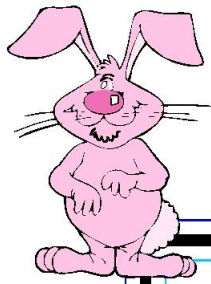

M I E B D K C I H C P I  
 A Z Z U O R S S L U Y V  
 E L L N Z E A P G A P L  
 E A B N V T O G R G M W  
 Q T C Y F S N T G I E B  
 T D A N B A W N E M N T  
 D Z B R F E W U L C E G  
 E T A L O C O H C K A T  
 H I D E Z C L C S K U Y  
 P A R A D E E A B L L D  
 B Z R S Y H B D I I H Y  
 N T D Z C K H P L K G E



Easter

eggs

bunny

basket

chocolate

parade

spring

dye

hunt

decorate

tulip

lily

hide

lamb

chick

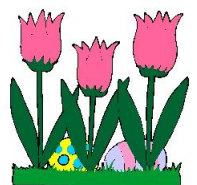

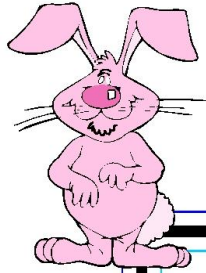

# HAPPY EASTER!



E	B	I	L	L	T	S	V	E	P	K	V
T	U	A	A	I	P	A	T	G	A	C	G
A	U	M	S	R	L	A	Q	T	R	I	Y
L	B	K	I	K	R	Y	R	G	A	H	V
O	R	N	I	O	E	E	Q	Z	D	C	S
C	G	S	C	I	Q	T	P	W	E	G	H
O	P	E	Y	N	N	U	B	I	G	H	I
H	D	E	Y	D	X	V	T	E	L	B	D
C	I	Q	C	T	H	V	N	U	J	U	E
E	A	S	T	E	R	F	S	F	I	C	T
I	E	K	E	H	W	W	H	N	O	T	Y
H	U	N	T	W	X	W	I	B	Q	A	L



Easter

eggs

bunny

basket

chocolate

parade

spring

dye

hunt

decorate

tulip

lily

hide

lamb

chick

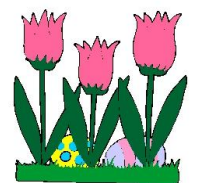
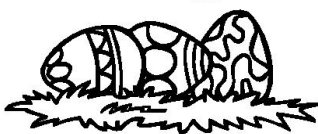



# Word Search: Easter

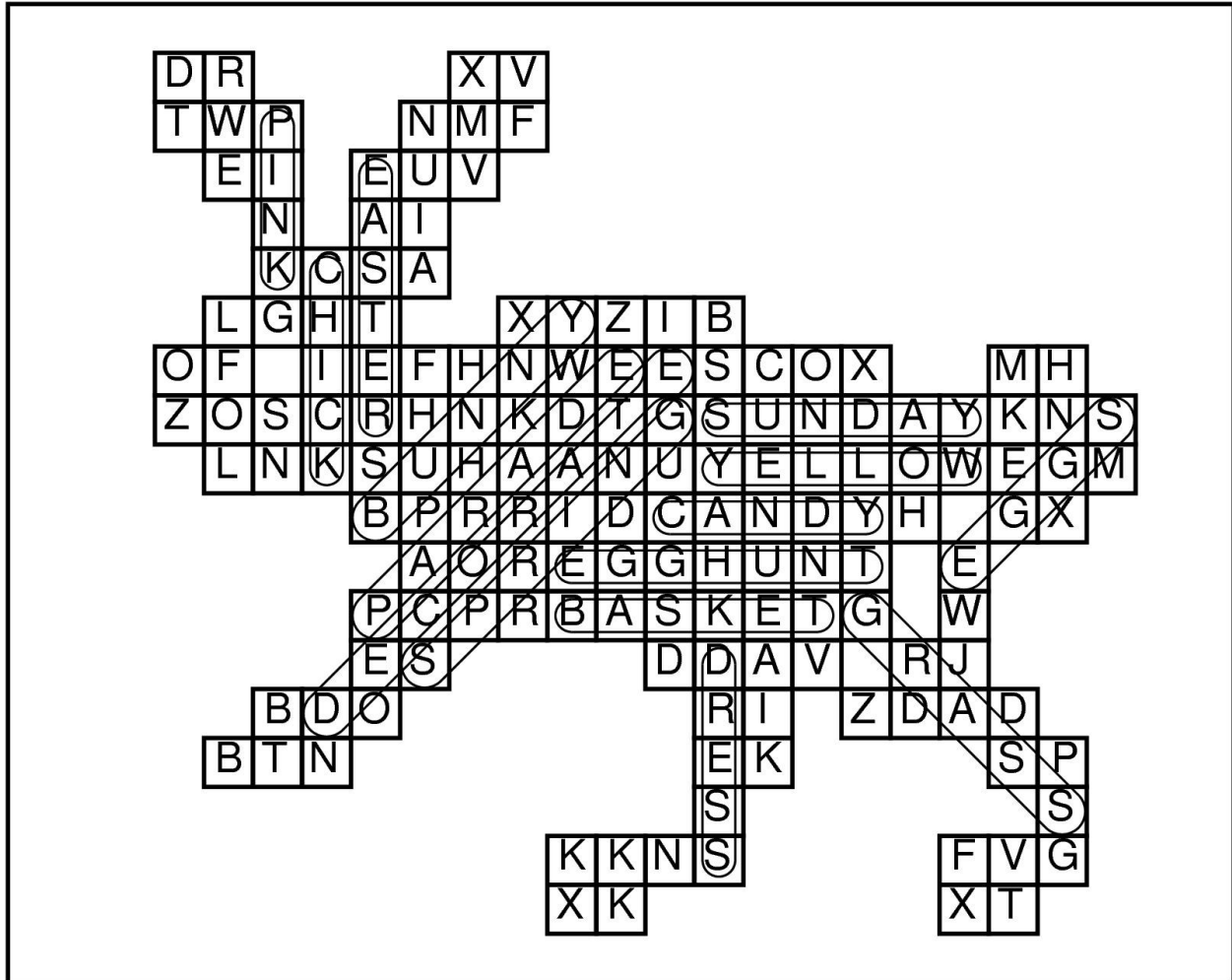

Easter

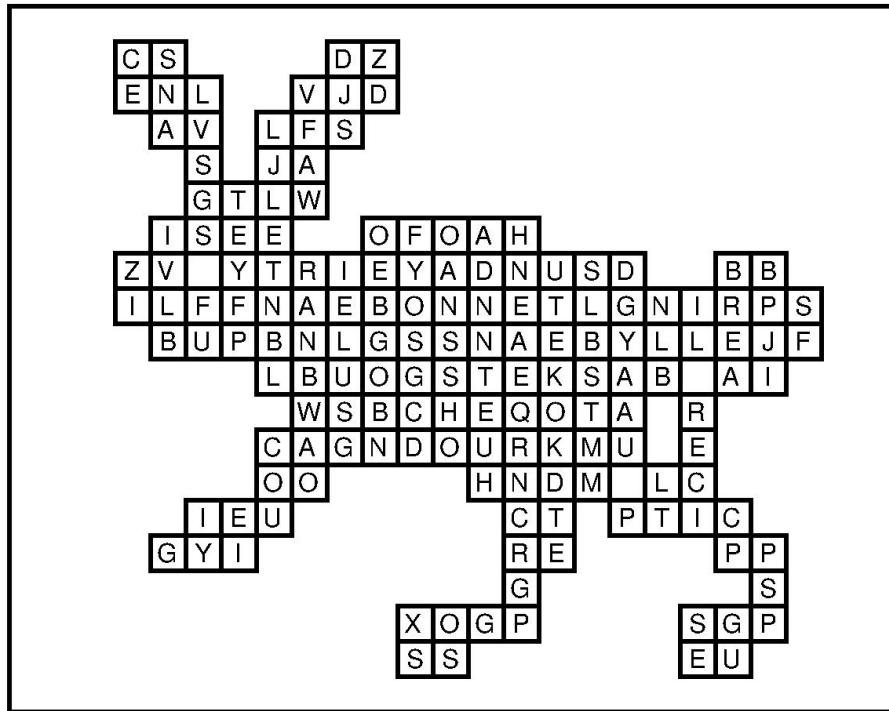

BASKETS  
EASTER EGG HUNT  
TULIPS

BONNET  
EGGS

BUNNY  
JELLY BEANS

CHOCOLATE  
SPRING

DRESS  
SUNDAY



# EASTER WORDSEARCH

*Search for the words:* basket bunny cake chick egg  
hen lamb spring duckling



P	T	N	A	S	H	G	S	T	Z
S	W	Q	P	B	X	S	P	H	C
S	V	M	D	A	A	Z	R	R	A
U	Q	B	T	S	C	H	I	C	K
M	D	U	C	K	L	I	N	G	E
H	E	N	E	E	A	L	G	K	G
Y	R	N	Q	T	M	M	O	I	G
Z	E	Y	L	V	B	Y	O	F	J





# Easter Word Search

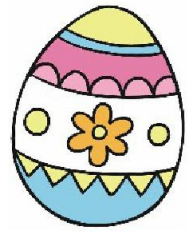

q	r	x	l	i	d	o	f	f	a	d	e
a	g	y	t	e	n	n	o	b	g	g	u
h	n	n	s	c	j	v	s	e	g	e	g
k	i	n	t	e	t	r	t	b	x	c	t
r	r	u	z	b	e	a	r	b	s	j	v
o	p	b	o	w	l	c	e	r	c	q	p
u	s	b	o	o	t	h	t	k	u	h	a
h	r	l	c	w	e	i	s	t	h	h	r
d	f	o	f	l	k	c	a	l	t	w	a
b	h	r	n	m	s	k	e	v	n	o	d
c	y	x	f	i	a	s	y	u	u	t	e
j	n	g	e	b	b	q	o	c	h	p	y

basket

bonnet

bunny

chicks

chocolate

daffodil

easter

egg

flowers

hunt

parade

spring

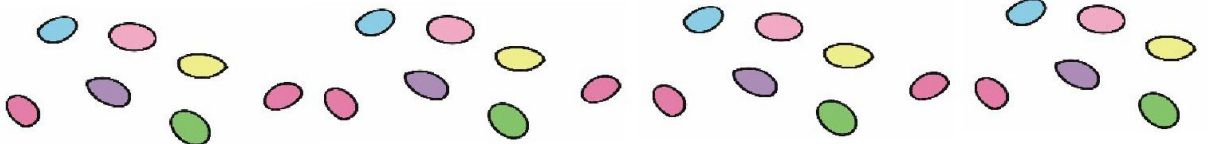

Copyright © www.ActivityVillage.co.uk - Keeping Kids Busy

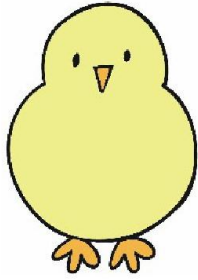

# Easter Word Search



e	w	m	s	b	u	n	n	y	s
a	u	f	l	o	w	e	r	e	b
s	s	g	c	y	x	z	d	l	i
t	p	e	h	b	a	s	k	e	t
e	r	y	i	r	b	w	j	b	b
r	i	v	c	d	o	c	g	m	h
c	n	d	k	x	n	e	g	g	l
l	g	y	s	o	n	v	a	z	s
a	y	h	p	p	e	q	j	f	w
a	z	z	g	f	t	p	m	q	d

basket

bonnet

bunny

chicks

easter

egg

flower

spring

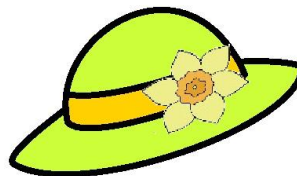
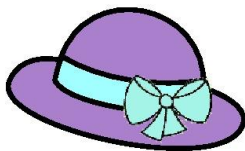

Copyright © www.ActivityVillage.co.uk - Keeping Kids Busy



# Easter Word Search



Find the words below in the grid to the left.



Basket  
 Bunny  
 Chocolate  
 Color  
 Decorate  
 Dinner

Dye  
 Easter  
 Egg  
 Hide  
 Hunt

Jelly Beans  
 Lily  
 Pattern  
 Rabbit  
 Spring



## Easter Wordsearch

P T N A S H G S T Z  
S W Q P B X S P H C  
S V M D A A Z R R A  
U Q B T S C H I C K  
M D U C K L I N G E  
H E N E E A L G K G  
Y R N Q T M M O I G  
Z E Y L V B Y O F J

### Search for the words

They are hidden left to right and down.

basket

bunny

cake

chick

duckling

egg

hen

lamb

spring



## Easter Sudocu

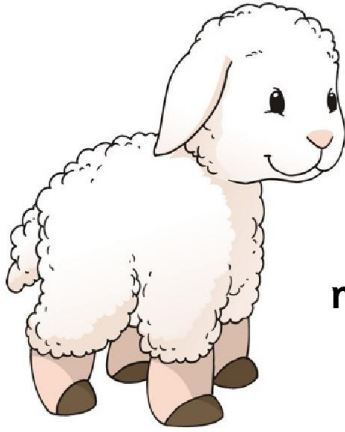

## Easter Sudoku

Every row, column and mini-grid must contain the letters L A M B .  
Don't guess - use logic

B			
			M
L			
			A



## Easter Sudoku

Every row, column and mini-grid  
must contain the letters L A M B .  
Don't guess - use logic

B	M	A	L
A	L	B	M
L	A	M	B
M	B	L	A



# Easter Sudoku

Every row, column and mini-grid must contain the letters H U N T .

Don't guess - use logic

	N		H
H		U	



[www.ActivityVillage.co.uk](http://www.ActivityVillage.co.uk) - Keeping Kids Busy





## Easter Sudoku

Every row, column and mini-grid must contain the letters H U N T .

Don't guess - use logic

U	N	T	H
T	H	N	U
N	U	H	T
H	T	U	N



[www.ActivityVillage.co.uk](http://www.ActivityVillage.co.uk) - Keeping Kids Busy



# Easter Sudoku

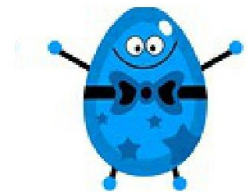

Every row, column and mini-grid must contain the letters E a s t e r. Don't guess - use logic

		E	r		
r					E
	E			a	
	r			s	
e					s
		a	t		

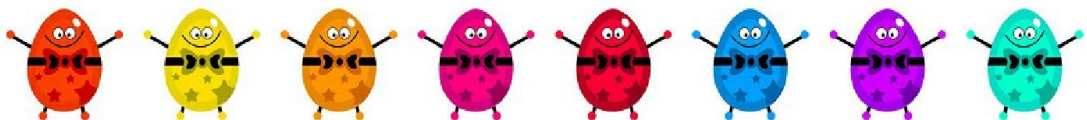



# Easter Sudoku

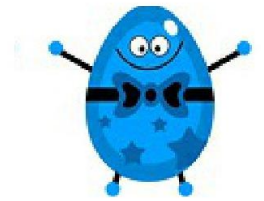

Every row, column and mini-grid must contain the letters E a s t e r. Don't guess - use logic

s	e	E	r	t	a
r	a	t	s	e	E
t	E	s	e	a	r
a	r	e	E	s	t
e	t	r	a	E	s
E	s	a	t	r	e

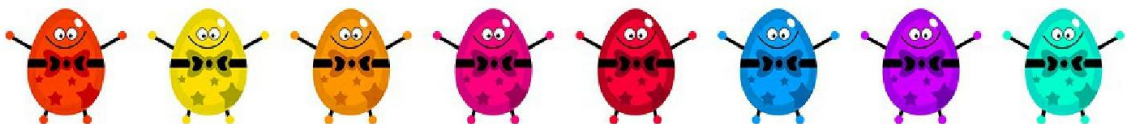



# Easter Sudoku

Every row, column and mini-grid must contain the letters **B A S K E T**

. Don't guess - use logic

		A	T		
	K			S	
B					K
A					B
	T			A	
		S	K		



## Easter Sudoku

Every row, column and mini-grid must contain the letters **B A S K E T**. Don't guess - use logic

S	B	A	T	K	E
T	K	E	B	S	A
B	S	T	A	E	K
A	E	K	S	T	B
K	T	B	E	A	S
E	A	S	K	B	T

# Let's Play Math!

## Count The Eggs!

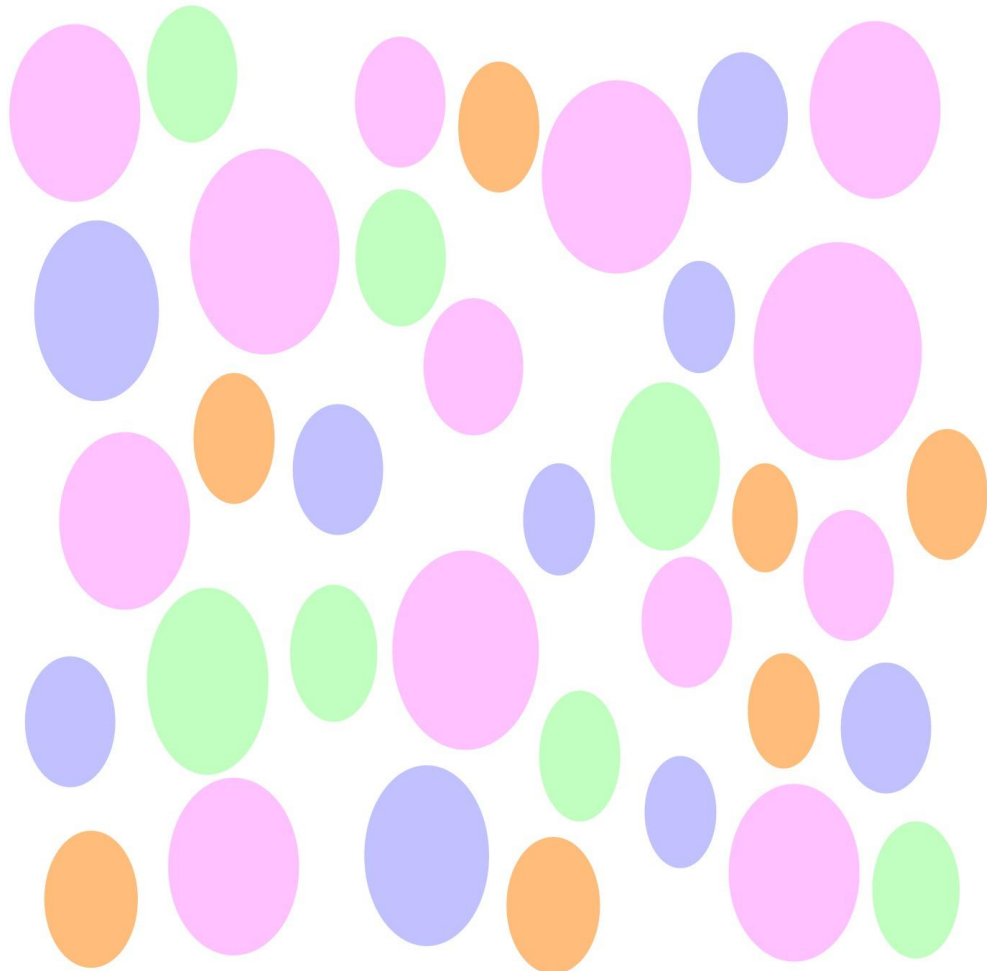

How many  
pink?



How many  
green?



How many  
blue?



How many  
orange?

[www.ActivityVillage.co.uk](http://www.ActivityVillage.co.uk) - Keeping Kids Busy

# Homework Mission

*Your mission is to make a mathematical board game for children aged 8-9.*

*Your game should include an Easter theme and a set of instructions.*



Ask yourself these questions when planning your game:

- How am I going to include maths in my game?
- How will the players move around the board?
- Should there be extra tasks to complete such as activities on cards?
- Do I need to make counters?
- Do I need to make dice using the net of a cube?

- How am I going to keep all the items needed for the game together?

You have 3 weeks to complete this mission. We will play the games in class after the holidays and there will be a prize for the most popular game.

**Good Luck and Happy Easter**



# Easter Egg Colour By Number

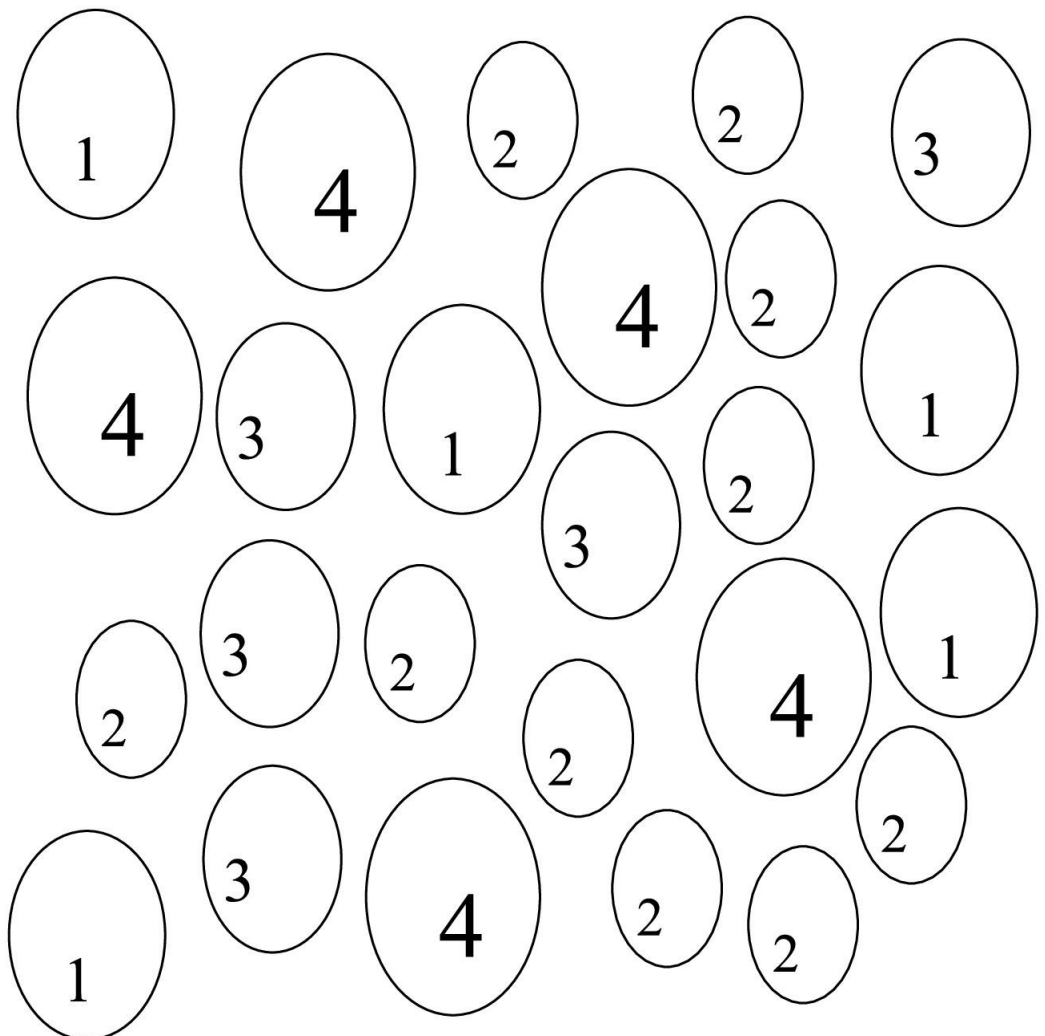

1 Colour these pink

3 Colour these green

2 Colour these blue

4 Colour these orange

How many eggs do you have of each colour?

Name:.....

Date:26/03/07

LO: Can I use information from a table to answer questions?

The corner shop has been very busy this week selling lots of Easter eggs. They have kept a record of how many of each different type have been sold. This is the table they produced.

Name of Easter egg	How many sold	Tally Chart Year3
Cadbury's Crème egg	27	
Nestle Milkybar egg	11	
Lindt Gold bunny	32	
Galaxy Caramel egg	8	
Nestle Rolo egg	16	

Answer these questions...

1. Which egg sold the most?
2. How many people bought the Galaxy Caramel egg?
3. How many people bought an egg made by Nestle?
4. How many Lindt Gold bunnies and Galaxy Caramel eggs were sold?

With a partner can you do a tally chart for peoples favourites in the class?

Record their answers on the table.

---

## EASTER HUNT - (A)

---

Instructions : Solve these Easter Math Problems

1. There are 4 purple eggs and 3 red eggs in John's basket. Calculate how many eggs there are in John's basket?

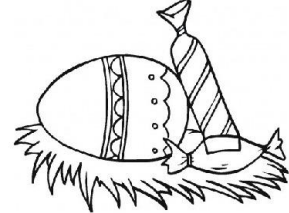

2. Michael found 2 eggs. Charlie found 1 egg. Joseph was happy because he had found exactly as many eggs as Michael and Charlie together. How many eggs did Joseph find? How many eggs were found in total?

3. Mark and teddy packed packages of Easter candy. Each Packet of Easter candy had 2 pieces. Mark packed 3 packages and Teddy packed 1 package. How many Easter candy packages are there in total? How many pieces of candy are there?

4. Three students in a class dyed one Easter egg each. To dye an egg they needed 2 purple dyes, 3 yellow dyes and 1 red dye. How many of each dye did the class have to purchase so every student could dye an Easter egg?

---

## EASTER HUNT - (A) Answers

---

Instructions : Solve these Easter Math Problems

1. There are 4 purple eggs and 3 red eggs in John's basket. Calculate how many eggs there are in John's basket?

Purple Eggs = 4 ; Red Eggs = 3  
Total Eggs in John's basket = Purple eggs + Red eggs = 4 + 3  
= 7 Total eggs

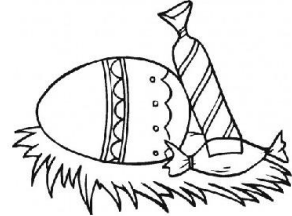

2. Michael found 2 eggs. Charlie found 1 egg. Joseph was happy because he had found exactly as many eggs as Michael and Charlie together. How many eggs did Joseph find? How many eggs were found in total?

Michael = 2 eggs ; Charlie = 1 eggs ; Joseph = ? ; Total Eggs = ?  
Joseph = 2 + 1 = 3 eggs  
Total eggs = Michael + Charlie + Joseph = 2 + 1 + 3 = 6 eggs

3. Mark and teddy packed packages of Easter candy. Each Packet of Easter candy had 2 pieces. Mark packed 3 packages and Teddy packed 1 package. How many Easter candy packages are there in total? How many pieces of candy are there?

One Packet of Easter candy = 2 pieces ; Mark packed = 3 packets ; Teddy packed = 1 packet  
Total Easter candy packets = Mark + Teddy = 3 + 1 = 4

Total number of candies = 4 \* 2 = 8 candy pieces

4. Three students in a class dyed one Easter egg each. To dye an egg they needed 2 purple dyes, 3 yellow dyes and 1 red dye. How many of each dye did the class have to purchase so every student could dye an Easter egg?

Total number of students = 3 ; One egg require = 2 purple + 3 yellow + 1 red dye  
Total Purple dye = 3 \* 2 ; Total Yellow dye = 3 \* 3 ; Total Red dye = 3 \* 1  
= 6 ; = 9 ; = 3

Name \_\_\_\_\_ Date \_\_\_\_\_



**It's Easter!**  
**Ordinal Numbers (1<sup>st</sup>-5<sup>th</sup>)**



**Read and follow the directions.**

1. Color the 4<sup>th</sup> basket.



2. Color the 2<sup>nd</sup> bunny.



3. Color the 5<sup>th</sup> Easter egg.

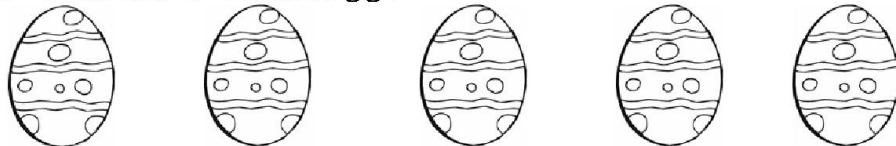

4. Color the 1<sup>st</sup> Easter chick.



5. Color the 3<sup>rd</sup> bunny.

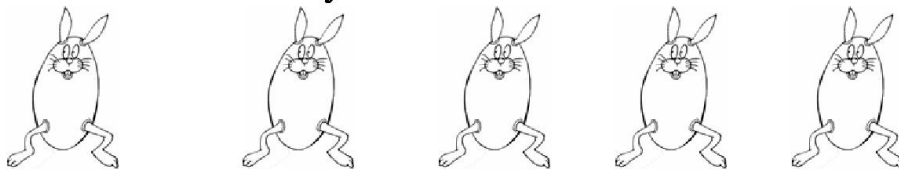



## Easter Multiplication Facts (A) Answers

	$\begin{array}{r} 12 \\ \times 2 \\ \hline 24 \end{array}$	$\begin{array}{r} 7 \\ \times 7 \\ \hline 49 \end{array}$	$\begin{array}{r} 9 \\ \times 9 \\ \hline 81 \end{array}$	$\begin{array}{r} 8 \\ \times 3 \\ \hline 24 \end{array}$	$\begin{array}{r} 8 \\ \times 3 \\ \hline 24 \end{array}$	$\begin{array}{r} 5 \\ \times 5 \\ \hline 25 \end{array}$				
$\begin{array}{r} 12 \\ \times 7 \\ \hline 84 \end{array}$	$\begin{array}{r} 7 \\ \times 7 \\ \hline 49 \end{array}$	$\begin{array}{r} 4 \\ \times 3 \\ \hline 12 \end{array}$	$\begin{array}{r} 5 \\ \times 12 \\ \hline 60 \end{array}$	$\begin{array}{r} 10 \\ \times 7 \\ \hline 70 \end{array}$	$\begin{array}{r} 9 \\ \times 8 \\ \hline 72 \end{array}$	$\begin{array}{r} 2 \\ \times 1 \\ \hline 2 \end{array}$	$\begin{array}{r} 6 \\ \times 3 \\ \hline 18 \end{array}$	$\begin{array}{r} 9 \\ \times 7 \\ \hline 63 \end{array}$	$\begin{array}{r} 7 \\ \times 8 \\ \hline 56 \end{array}$	
$\begin{array}{r} 3 \\ \times 1 \\ \hline 3 \end{array}$	$\begin{array}{r} 3 \\ \times 11 \\ \hline 33 \end{array}$	$\begin{array}{r} 7 \\ \times 7 \\ \hline 49 \end{array}$	$\begin{array}{r} 2 \\ \times 3 \\ \hline 6 \end{array}$	$\begin{array}{r} 8 \\ \times 6 \\ \hline 48 \end{array}$	$\begin{array}{r} 9 \\ \times 6 \\ \hline 54 \end{array}$	$\begin{array}{r} 6 \\ \times 11 \\ \hline 66 \end{array}$	$\begin{array}{r} 6 \\ \times 8 \\ \hline 48 \end{array}$	$\begin{array}{r} 7 \\ \times 3 \\ \hline 21 \end{array}$	$\begin{array}{r} 3 \\ \times 10 \\ \hline 30 \end{array}$	
$\begin{array}{r} 7 \\ \times 3 \\ \hline 21 \end{array}$	$\begin{array}{r} 2 \\ \times 2 \\ \hline 4 \end{array}$	$\begin{array}{r} 3 \\ \times 6 \\ \hline 18 \end{array}$	$\begin{array}{r} 12 \\ \times 7 \\ \hline 84 \end{array}$	$\begin{array}{r} 9 \\ \times 5 \\ \hline 45 \end{array}$	$\begin{array}{r} 5 \\ \times 1 \\ \hline 5 \end{array}$	$\begin{array}{r} 5 \\ \times 4 \\ \hline 20 \end{array}$	$\begin{array}{r} 4 \\ \times 9 \\ \hline 36 \end{array}$	$\begin{array}{r} 11 \\ \times 11 \\ \hline 121 \end{array}$	$\begin{array}{r} 12 \\ \times 10 \\ \hline 120 \end{array}$	
$\begin{array}{r} 1 \\ \times 9 \\ \hline 9 \end{array}$	$\begin{array}{r} 10 \\ \times 9 \\ \hline 90 \end{array}$	$\begin{array}{r} 1 \\ \times 10 \\ \hline 10 \end{array}$	$\begin{array}{r} 10 \\ \times 11 \\ \hline 110 \end{array}$	$\begin{array}{r} 10 \\ \times 3 \\ \hline 30 \end{array}$	$\begin{array}{r} 7 \\ \times 10 \\ \hline 70 \end{array}$	$\begin{array}{r} 11 \\ \times 6 \\ \hline 66 \end{array}$	$\begin{array}{r} 5 \\ \times 6 \\ \hline 30 \end{array}$	$\begin{array}{r} 12 \\ \times 11 \\ \hline 132 \end{array}$	$\begin{array}{r} 10 \\ \times 8 \\ \hline 80 \end{array}$	
$\begin{array}{r} 11 \\ \times 6 \\ \hline 66 \end{array}$	$\begin{array}{r} 4 \\ \times 5 \\ \hline 20 \end{array}$	$\begin{array}{r} 2 \\ \times 8 \\ \hline 16 \end{array}$	$\begin{array}{r} 10 \\ \times 9 \\ \hline 90 \end{array}$	$\begin{array}{r} 2 \\ \times 8 \\ \hline 16 \end{array}$	$\begin{array}{r} 10 \\ \times 6 \\ \hline 60 \end{array}$	$\begin{array}{r} 12 \\ \times 9 \\ \hline 108 \end{array}$	$\begin{array}{r} 6 \\ \times 7 \\ \hline 42 \end{array}$	$\begin{array}{r} 8 \\ \times 2 \\ \hline 16 \end{array}$	$\begin{array}{r} 7 \\ \times 8 \\ \hline 56 \end{array}$	
$\begin{array}{r} 3 \\ \times 10 \\ \hline 30 \end{array}$	$\begin{array}{r} 12 \\ \times 11 \\ \hline 132 \end{array}$	$\begin{array}{r} 7 \\ \times 6 \\ \hline 42 \end{array}$	$\begin{array}{r} 2 \\ \times 8 \\ \hline 16 \end{array}$	$\begin{array}{r} 7 \\ \times 3 \\ \hline 21 \end{array}$	$\begin{array}{r} 1 \\ \times 3 \\ \hline 3 \end{array}$	$\begin{array}{r} 2 \\ \times 4 \\ \hline 8 \end{array}$	$\begin{array}{r} 3 \\ \times 4 \\ \hline 12 \end{array}$	$\begin{array}{r} 8 \\ \times 4 \\ \hline 32 \end{array}$	$\begin{array}{r} 8 \\ \times 6 \\ \hline 48 \end{array}$	
$\begin{array}{r} 11 \\ \times 7 \\ \hline 77 \end{array}$	$\begin{array}{r} 5 \\ \times 1 \\ \hline 5 \end{array}$	$\begin{array}{r} 8 \\ \times 5 \\ \hline 40 \end{array}$	$\begin{array}{r} 7 \\ \times 6 \\ \hline 42 \end{array}$	$\begin{array}{r} 5 \\ \times 9 \\ \hline 45 \end{array}$	$\begin{array}{r} 8 \\ \times 8 \\ \hline 64 \end{array}$	$\begin{array}{r} 5 \\ \times 9 \\ \hline 45 \end{array}$	$\begin{array}{r} 11 \\ \times 8 \\ \hline 88 \end{array}$	$\begin{array}{r} 5 \\ \times 12 \\ \hline 60 \end{array}$	$\begin{array}{r} 2 \\ \times 1 \\ \hline 2 \end{array}$	
$\begin{array}{r} 10 \\ \times 7 \\ \hline 70 \end{array}$	$\begin{array}{r} 3 \\ \times 11 \\ \hline 33 \end{array}$	$\begin{array}{r} 8 \\ \times 8 \\ \hline 64 \end{array}$	$\begin{array}{r} 1 \\ \times 2 \\ \hline 2 \end{array}$	$\begin{array}{r} 6 \\ \times 3 \\ \hline 18 \end{array}$	$\begin{array}{r} 3 \\ \times 6 \\ \hline 18 \end{array}$	$\begin{array}{r} 5 \\ \times 2 \\ \hline 10 \end{array}$	$\begin{array}{r} 10 \\ \times 3 \\ \hline 30 \end{array}$	$\begin{array}{r} 8 \\ \times 10 \\ \hline 80 \end{array}$	$\begin{array}{r} 7 \\ \times 5 \\ \hline 35 \end{array}$	
	$\begin{array}{r} 12 \\ \times 3 \\ \hline 36 \end{array}$	$\begin{array}{r} 8 \\ \times 2 \\ \hline 16 \end{array}$	$\begin{array}{r} 7 \\ \times 5 \\ \hline 35 \end{array}$	$\begin{array}{r} 4 \\ \times 7 \\ \hline 28 \end{array}$	$\begin{array}{r} 5 \\ \times 6 \\ \hline 30 \end{array}$	$\begin{array}{r} 6 \\ \times 1 \\ \hline 6 \end{array}$				

Happy Easter from [www.math-drills.com](http://www.math-drills.com)

# Easter Multiplication Problems

1. Evan and his dad painted Easter eggs for an Easter egg hunt. For every egg that Evan painted, his dad painted six eggs. If Evan painted 19 eggs, how many eggs were in the hunt?
2. Denise noticed that packages of Easter candy had an average of 34 pieces. She purchased 8 packages of candy. Estimate how many pieces of candy she purchased. Exactly how many pieces of candy did she purchase?
3. Janine made a rectangle with Easter stickers that was 14 stickers long and 15 stickers wide. How many stickers were in her rectangle? Sketch the rectangle.
4. Pablo was really excited that he got four days off for Easter. "I know how many hours there are in four days!" Pablo said proudly. What number did Pablo say?
5. Twenty-seven students in a grade four class were making Easter baskets for their parents. Each student made one basket that contained three chocolate bunnies, sixteen jelly beans, fourteen foil-wrapped chocolate eggs, two Easter decorations, and thirty-seven miscellaneous candies. How many of each item will the class have to purchase so every student can make one basket?
6. Emily wanted to send all of her relatives an Easter card. She sent 21 cards to the United States at a cost of 39 cents each and 7 cards to Canada at a cost of 63 cents each. Each card cost her 56 cents to buy. How much did Emily spend on cards and postage?

Get thousands of free math worksheets at <http://www.math-drills.com>



## Easter Word Problems



Remember to underline the important bits first and to decide what operation to do!



(not this sort of operation!!)

1. The post office is selling eggs for £ 1.79 each or £5.50 for 3. Which is better value and why?
2. 110g of chocolate is needed to make 1 small egg. A large egg needs 3 times this amount. How much chocolate is needed for 2 large and 2 small eggs?
3. A packet of mini eggs contains 23 eggs. There are 44 children in Y5. How many packets should Mrs Rodger buy so that each child gets 3 eggs each?
4. How much would these eggs be with 50%, 25% off?  
Mars: £ 4.76      Nemo: £2.38      Ferrero: £ 6. 98

**Now make up some Easter problems for your friends to solve!!**

# Easter Bunny Feeding Time (B)

Instructions: Easter bunnies ate several of the digits on this page because they thought it was grass. Can you fill in the missing digits?

$$\begin{array}{r} 31 \\ + \square 3 \\ \hline 6\square \end{array}$$

$$\begin{array}{r} 4 \\ \times 2 \\ \hline \square \end{array}$$

$$\begin{array}{r} 7\square \\ - 24 \\ \hline \square 2 \end{array}$$

$$\begin{array}{r} \square 1 \\ \times \square \\ \hline 5 \end{array}$$

$$\begin{array}{r} \square \\ \times 6 \\ \hline 12 \end{array}$$

$$\begin{array}{r} 10\square \\ - 21 \\ \hline \square 2 \end{array}$$

$$\begin{array}{r} \square 1 \\ + 4\square \\ \hline 73 \end{array}$$

$$\begin{array}{r} \square 9 \\ - 52 \\ \hline 3\square \end{array}$$

$$\begin{array}{r} \square \\ \times 4 \\ \hline 36 \end{array}$$

$$\begin{array}{r} 7\square \\ + 93 \\ \hline 1\square 4 \end{array}$$

$$\begin{array}{r} 11\square \\ - \square 7 \\ \hline 91 \end{array}$$

$$\begin{array}{r} 43 \\ + \square 8 \\ \hline 8\square \end{array}$$

$$\begin{array}{r} \square 2 \\ + \square 6 \\ \hline 110 \end{array}$$

$$\begin{array}{r} 1\square 4 \\ - 97 \\ \hline 6\square \end{array}$$

$$\begin{array}{r} 6 \\ \times \square \\ \hline 18 \end{array}$$

$$\begin{array}{r} 7 \\ \times \square \\ \hline 28 \end{array}$$

$$\begin{array}{r} 6 \\ \times 1 \\ \hline \square \end{array}$$

$$\begin{array}{r} 1\square \\ + 48 \\ \hline \square 9 \end{array}$$

$$\begin{array}{r} \square \\ \times 4 \\ \hline 1\square 4 \end{array}$$

$$\begin{array}{r} \square 3 \\ + 5\square \\ \hline 97 \end{array}$$



$$\begin{array}{r} \square \\ \times 3 \\ \hline 24 \end{array}$$

$$\begin{array}{r} 1\square 0 \\ - 66 \\ \hline 9\square \end{array}$$

Happy Easter from [www.math-drills.com](http://www.math-drills.com)

# Easter Bunny Feeding Time (B) Answers

Instructions: Easter bunnies ate several of the digits on this page because they thought it was grass.  
Can you fill in the missing digits?

$$\begin{array}{r} 31 \\ + 33 \\ \hline 64 \end{array}$$

$$\begin{array}{r} 4 \\ \times 2 \\ \hline 8 \end{array}$$

$$\begin{array}{r} 76 \\ - 24 \\ \hline 52 \end{array}$$

$$\begin{array}{r} 1 \\ \times 5 \\ \hline 5 \end{array}$$

$$\begin{array}{r} 2 \\ \times 6 \\ \hline 12 \end{array}$$

$$\begin{array}{r} 103 \\ - 21 \\ \hline 82 \end{array}$$

$$\begin{array}{r} 31 \\ + 42 \\ \hline 73 \end{array}$$

$$\begin{array}{r} 89 \\ - 52 \\ \hline 37 \end{array}$$

$$\begin{array}{r} 9 \\ \times 4 \\ \hline 36 \end{array}$$

$$\begin{array}{r} 71 \\ + 93 \\ \hline 164 \end{array}$$

$$\begin{array}{r} 118 \\ - 27 \\ \hline 91 \end{array}$$

$$\begin{array}{r} 43 \\ + 38 \\ \hline 81 \end{array}$$

$$\begin{array}{r} 24 \\ + 86 \\ \hline 110 \end{array}$$

$$\begin{array}{r} 164 \\ - 97 \\ \hline 67 \end{array}$$

$$\begin{array}{r} 6 \\ \times 3 \\ \hline 18 \end{array}$$

$$\begin{array}{r} 7 \\ \times 4 \\ \hline 28 \end{array}$$

$$\begin{array}{r} 6 \\ \times 1 \\ \hline 6 \end{array}$$

$$\begin{array}{r} 11 \\ + 48 \\ \hline 59 \end{array}$$

$$\begin{array}{r} 4 \\ \times 4 \\ \hline 16 \end{array}$$

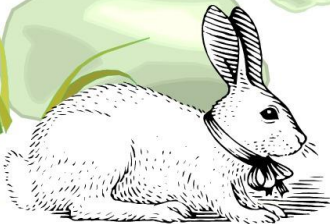
$$\begin{array}{r} 43 \\ + 54 \\ \hline 97 \end{array}$$







$$\begin{array}{r} 8 \\ \times 3 \\ \hline 24 \end{array}$$





$$\begin{array}{r} 160 \\ - 66 \\ \hline 94 \end{array}$$

Happy Easter from [www.math-drills.com](http://www.math-drills.com)

## Easter Eggs in a Basket - Sums to 18 (A)

Instructions: Each addition question represents an Easter egg. Only Easter eggs with sums greater than 4 may be put into the basket.



	$\begin{array}{r} 5 \\ + 7 \\ \hline \end{array}$		$\begin{array}{r} 1 \\ + 3 \\ \hline \end{array}$		$\begin{array}{r} 8 \\ + 8 \\ \hline \end{array}$		$\begin{array}{r} 1 \\ + 4 \\ \hline \end{array}$		$\begin{array}{r} 5 \\ + 1 \\ \hline \end{array}$
---	---	---	---	---	---	--	---	---	---

	$\begin{array}{r} 7 \\ + 3 \\ \hline \end{array}$		$\begin{array}{r} 8 \\ + 4 \\ \hline \end{array}$		$\begin{array}{r} 4 \\ + 7 \\ \hline \end{array}$		$\begin{array}{r} 4 \\ + 4 \\ \hline \end{array}$		$\begin{array}{r} 2 \\ + 1 \\ \hline \end{array}$
---	---	---	---	---	---	--	---	---	---

	$\begin{array}{r} 3 \\ + 7 \\ \hline \end{array}$		$\begin{array}{r} 8 \\ + 7 \\ \hline \end{array}$		$\begin{array}{r} 4 \\ + 8 \\ \hline \end{array}$		$\begin{array}{r} 6 \\ + 5 \\ \hline \end{array}$
---	---	---	---	--	---	---	---

	$\begin{array}{r} 1 \\ + 6 \\ \hline \end{array}$		$\begin{array}{r} 6 \\ + 6 \\ \hline \end{array}$
--	---	--	---

	$\begin{array}{r} 3 \\ + 2 \\ \hline \end{array}$		$\begin{array}{r} 9 \\ + 3 \\ \hline \end{array}$
---	---	---	---

	$\begin{array}{r} 8 \\ + 4 \\ \hline \end{array}$		$\begin{array}{r} 3 \\ + 3 \\ \hline \end{array}$
---	---	---	---



How many  
Easter eggs go  
in the basket?

Answer:

Happy Easter from [www.math-drills.com](http://www.math-drills.com)

## Easter Eggs in a Basket - Sums to 18 (A) Answers

Instructions: Each addition question represents an Easter egg. Only Easter eggs with sums greater than 4 may be put into the basket.

$\begin{array}{r} 5 \\ + 7 \\ \hline \end{array}$ Yes    12	$\begin{array}{r} 1 \\ + 3 \\ \hline \end{array}$ No    4	$\begin{array}{r} 8 \\ + 8 \\ \hline \end{array}$ Yes    16	$\begin{array}{r} 1 \\ + 4 \\ \hline \end{array}$ Yes    5	$\begin{array}{r} 5 \\ + 1 \\ \hline \end{array}$ Yes    6
---	---	---	--	--

$\begin{array}{r} 7 \\ + 3 \\ \hline \end{array}$ Yes    10	$\begin{array}{r} 8 \\ + 4 \\ \hline \end{array}$ Yes    12	$\begin{array}{r} 4 \\ + 7 \\ \hline \end{array}$ Yes    11	$\begin{array}{r} 4 \\ + 4 \\ \hline \end{array}$ Yes    8	$\begin{array}{r} 2 \\ + 1 \\ \hline \end{array}$ No    3
---	---	---	--	---

$\begin{array}{r} 3 \\ + 7 \\ \hline \end{array}$ Yes    10	$\begin{array}{r} 8 \\ + 7 \\ \hline \end{array}$ Yes    15	$\begin{array}{r} 4 \\ + 8 \\ \hline \end{array}$ Yes    12	$\begin{array}{r} 6 \\ + 5 \\ \hline \end{array}$ Yes    11
---	---	---	---

$\begin{array}{r} 1 \\ + 6 \\ \hline \end{array}$ Yes    7	$\begin{array}{r} 6 \\ + 6 \\ \hline \end{array}$ Yes    12
--	---

$\begin{array}{r} 3 \\ + 2 \\ \hline \end{array}$ Yes    5	$\begin{array}{r} 9 \\ + 3 \\ \hline \end{array}$ Yes    12
--	---

$\begin{array}{r} 8 \\ + 4 \\ \hline \end{array}$ Yes    12	$\begin{array}{r} 3 \\ + 3 \\ \hline \end{array}$ Yes    6
---	--

How many  
Easter eggs go  
in the basket?





Answer:





18
----

Happy Easter from [www.math-drills.com](http://www.math-drills.com)

## Easter Eggs in a Basket - Sums to 50 (A)

Instructions: Each addition question represents an Easter egg. Only Easter eggs with sums greater than 22 may be put into the basket.



	$10$		$16$		$8$		$20$		$10$
$+$	$7$	$+$	$3$	$+$	$6$	$+$	$7$	$+$	$22$
<hr/>									

	$5$		$15$		$13$		$18$		$6$
$+$	$24$	$+$	$25$	$+$	$23$	$+$	$2$	$+$	$19$
<hr/>									

	$8$		$18$		$16$		$14$
$+$	$8$	$+$	$9$	$+$	$3$	$+$	$11$
<hr/>							

	$18$		$2$
$+$	$12$	$+$	$22$
<hr/>			

	$23$		$25$
$+$	$13$	$+$	$14$
<hr/>			

	$8$		$6$
$+$	$8$	$+$	$19$
<hr/>			



How many  
Easter eggs go  
in the basket?

Answer:

Happy Easter from [www.math-drills.com](http://www.math-drills.com)

## Easter Eggs in a Basket - Sums to 50 (A) Answers

Instructions: Each addition question represents an Easter egg. Only Easter eggs with sums greater than 22 may be put into the basket.

$$\begin{array}{r} 10 \\ + 7 \\ \hline \end{array}$$

No      17

$$\begin{array}{r} 16 \\ + 3 \\ \hline \end{array}$$

No      19

$$\begin{array}{r} 8 \\ + 6 \\ \hline \end{array}$$

No      14

$$\begin{array}{r} 20 \\ + 7 \\ \hline \end{array}$$

Yes     27

$$\begin{array}{r} 10 \\ + 22 \\ \hline \end{array}$$

Yes     32

$$\begin{array}{r} 5 \\ + 24 \\ \hline \end{array}$$

Yes     29

$$\begin{array}{r} 15 \\ + 25 \\ \hline \end{array}$$

Yes     40

$$\begin{array}{r} 13 \\ + 23 \\ \hline \end{array}$$

Yes     36

$$\begin{array}{r} 18 \\ + 2 \\ \hline \end{array}$$

No      20

$$\begin{array}{r} 6 \\ + 19 \\ \hline \end{array}$$

Yes     25

$$\begin{array}{r} 8 \\ + 8 \\ \hline \end{array}$$

No      16

$$\begin{array}{r} 18 \\ + 9 \\ \hline \end{array}$$

Yes     27

$$\begin{array}{r} 16 \\ + 3 \\ \hline \end{array}$$

No      19

$$\begin{array}{r} 14 \\ + 11 \\ \hline \end{array}$$

Yes     25

$$\begin{array}{r} 18 \\ + 12 \\ \hline \end{array}$$

Yes     30

$$\begin{array}{r} 2 \\ + 22 \\ \hline \end{array}$$

Yes     24

$$\begin{array}{r} 23 \\ + 13 \\ \hline \end{array}$$

Yes     36

$$\begin{array}{r} 25 \\ + 14 \\ \hline \end{array}$$

Yes     39

$$\begin{array}{r} 8 \\ + 8 \\ \hline \end{array}$$

No      16

$$\begin{array}{r} 6 \\ + 19 \\ \hline \end{array}$$

Yes     25

How many  
Easter eggs go  
in the basket?

Answer:

13
----

Happy Easter from [www.math-drills.com](http://www.math-drills.com)

## Easter Eggs in a Basket - Sums to 198 (A)

Instructions: Each addition question represents an Easter egg. Only Easter eggs with sums greater than 97 may be put into the basket.



$$\begin{array}{r} 61 \\ + 35 \\ \hline \end{array}$$



$$\begin{array}{r} 19 \\ + 32 \\ \hline \end{array}$$



$$\begin{array}{r} 23 \\ + 47 \\ \hline \end{array}$$

$$\begin{array}{r} 69 \\ + 88 \\ \hline \end{array}$$



$$\begin{array}{r} 97 \\ + 17 \\ \hline \end{array}$$



$$\begin{array}{r} 30 \\ + 38 \\ \hline \end{array}$$

$$\begin{array}{r} 41 \\ + 86 \\ \hline \end{array}$$

$$\begin{array}{r} 87 \\ + 14 \\ \hline \end{array}$$



$$\begin{array}{r} 92 \\ + 44 \\ \hline \end{array}$$



$$\begin{array}{r} 30 \\ + 69 \\ \hline \end{array}$$

$$\begin{array}{r} 13 \\ + 85 \\ \hline \end{array}$$



$$\begin{array}{r} 33 \\ + 24 \\ \hline \end{array}$$

$$\begin{array}{r} 63 \\ + 52 \\ \hline \end{array}$$



$$\begin{array}{r} 93 \\ + 62 \\ \hline \end{array}$$



$$\begin{array}{r} 60 \\ + 46 \\ \hline \end{array}$$

$$\begin{array}{r} 65 \\ + 12 \\ \hline \end{array}$$

$$\begin{array}{r} 73 \\ + 88 \\ \hline \end{array}$$

$$\begin{array}{r} 14 \\ + 54 \\ \hline \end{array}$$

$$\begin{array}{r} 73 \\ + 59 \\ \hline \end{array}$$

$$\begin{array}{r} 58 \\ + 67 \\ \hline \end{array}$$



How many  
Easter eggs go  
in the basket?

Answer:

Happy Easter from [www.math-drills.com](http://www.math-drills.com)



## Easter Eggs in a Basket - Sums to 198 (A) Answers

Instructions: Each addition question represents an Easter egg. Only Easter eggs with sums greater than 97 may be put into the basket.

$$\begin{array}{r} 61 \\ + 35 \\ \hline \end{array}$$

No      96

$$\begin{array}{r} 19 \\ + 32 \\ \hline \end{array}$$

No      51

$$\begin{array}{r} 23 \\ + 47 \\ \hline \end{array}$$

No      70

$$\begin{array}{r} 69 \\ + 88 \\ \hline \end{array}$$

Yes     157

$$\begin{array}{r} 97 \\ + 17 \\ \hline \end{array}$$

Yes     114

$$\begin{array}{r} 30 \\ + 38 \\ \hline \end{array}$$

No      68

$$\begin{array}{r} 41 \\ + 86 \\ \hline \end{array}$$

Yes     127

$$\begin{array}{r} 87 \\ + 14 \\ \hline \end{array}$$

Yes     101

$$\begin{array}{r} 92 \\ + 44 \\ \hline \end{array}$$

Yes     136

$$\begin{array}{r} 30 \\ + 69 \\ \hline \end{array}$$

Yes     99

$$\begin{array}{r} 13 \\ + 85 \\ \hline \end{array}$$

Yes     98

$$\begin{array}{r} 33 \\ + 24 \\ \hline \end{array}$$

No      57

$$\begin{array}{r} 63 \\ + 52 \\ \hline \end{array}$$

Yes     115

$$\begin{array}{r} 93 \\ + 62 \\ \hline \end{array}$$

Yes     155

$$\begin{array}{r} 60 \\ + 46 \\ \hline \end{array}$$

Yes     106

$$\begin{array}{r} 65 \\ + 12 \\ \hline \end{array}$$

No      77

$$\begin{array}{r} 73 \\ + 88 \\ \hline \end{array}$$

Yes     161

$$\begin{array}{r} 14 \\ + 54 \\ \hline \end{array}$$

No      68

$$\begin{array}{r} 73 \\ + 59 \\ \hline \end{array}$$

Yes     132

$$\begin{array}{r} 58 \\ + 67 \\ \hline \end{array}$$

Yes     125

How many  
Easter eggs go  
in the basket?

Answer:

13
----

Happy Easter from [www.math-drills.com](http://www.math-drills.com)

## Easter Eggs in a Basket - Sums to 198 (A) Answers

Instructions: Each addition question represents an Easter egg. Only Easter eggs with sums greater than 97 may be put into the basket.

$$\begin{array}{r} 61 \\ + 35 \\ \hline \end{array}$$

No 96

$$\begin{array}{r} 19 \\ + 32 \\ \hline \end{array}$$

No 51

$$\begin{array}{r} 23 \\ + 47 \\ \hline \end{array}$$

No 70

$$\begin{array}{r} 69 \\ + 88 \\ \hline \end{array}$$

Yes 157

$$\begin{array}{r} 97 \\ + 17 \\ \hline \end{array}$$

Yes 114

$$\begin{array}{r} 30 \\ + 38 \\ \hline \end{array}$$

No 68

$$\begin{array}{r} 41 \\ + 86 \\ \hline \end{array}$$

Yes 127

$$\begin{array}{r} 87 \\ + 14 \\ \hline \end{array}$$

Yes 101

$$\begin{array}{r} 92 \\ + 44 \\ \hline \end{array}$$

Yes 136

$$\begin{array}{r} 30 \\ + 69 \\ \hline \end{array}$$

Yes 99

$$\begin{array}{r} 13 \\ + 85 \\ \hline \end{array}$$

Yes 98

$$\begin{array}{r} 33 \\ + 24 \\ \hline \end{array}$$

No 57

$$\begin{array}{r} 63 \\ + 52 \\ \hline \end{array}$$

Yes 115

$$\begin{array}{r} 93 \\ + 62 \\ \hline \end{array}$$

Yes 155

$$\begin{array}{r} 60 \\ + 46 \\ \hline \end{array}$$

Yes 106

$$\begin{array}{r} 65 \\ + 12 \\ \hline \end{array}$$

No 77

$$\begin{array}{r} 73 \\ + 88 \\ \hline \end{array}$$

Yes 161

$$\begin{array}{r} 14 \\ + 54 \\ \hline \end{array}$$

No 68

$$\begin{array}{r} 73 \\ + 59 \\ \hline \end{array}$$

Yes 132

$$\begin{array}{r} 58 \\ + 67 \\ \hline \end{array}$$

Yes 125

How many  
Easter eggs go  
in the basket?

Answer:

13

Happy Easter from [www.math-drills.com](http://www.math-drills.com)

## Easter Eggs in a Basket - Sums to 1998 (A)

Instructions: Each addition question represents an Easter egg. Only Easter eggs with sums greater than 994 may be put into the basket.

$$\begin{array}{r} 110 \\ + 433 \\ \hline \end{array}$$

$$\begin{array}{r} 923 \\ + 641 \\ \hline \end{array}$$



$$\begin{array}{r} 612 \\ + 592 \\ \hline \end{array}$$

$$\begin{array}{r} 670 \\ + 170 \\ \hline \end{array}$$

$$\begin{array}{r} 812 \\ + 609 \\ \hline \end{array}$$



$$\begin{array}{r} 220 \\ + 221 \\ \hline \end{array}$$

$$\begin{array}{r} 751 \\ + 876 \\ \hline \end{array}$$

$$\begin{array}{r} 577 \\ + 421 \\ \hline \end{array}$$

$$\begin{array}{r} 959 \\ + 493 \\ \hline \end{array}$$

$$\begin{array}{r} 385 \\ + 964 \\ \hline \end{array}$$

$$\begin{array}{r} 466 \\ + 291 \\ \hline \end{array}$$



$$\begin{array}{r} 723 \\ + 977 \\ \hline \end{array}$$

$$\begin{array}{r} 617 \\ + 335 \\ \hline \end{array}$$



$$\begin{array}{r} 146 \\ + 618 \\ \hline \end{array}$$

$$\begin{array}{r} 593 \\ + 251 \\ \hline \end{array}$$

$$\begin{array}{r} 996 \\ + 133 \\ \hline \end{array}$$

$$\begin{array}{r} 921 \\ + 428 \\ \hline \end{array}$$

$$\begin{array}{r} 999 \\ + 779 \\ \hline \end{array}$$

$$\begin{array}{r} 407 \\ + 410 \\ \hline \end{array}$$

$$\begin{array}{r} 406 \\ + 665 \\ \hline \end{array}$$



How many  
Easter eggs go  
in the basket?

Answer:

Happy Easter from [www.math-drills.com](http://www.math-drills.com)

## Easter Eggs in a Basket - Sums to 1998 (A) Answers

Instructions: Each addition question represents an Easter egg. Only Easter eggs with sums greater than 994 may be put into the basket.

$\begin{array}{r} 110 \\ + 433 \\ \hline \end{array}$	$\begin{array}{r} 923 \\ + 641 \\ \hline \end{array}$	$\begin{array}{r} 612 \\ + 592 \\ \hline \end{array}$	$\begin{array}{r} 670 \\ + 170 \\ \hline \end{array}$	$\begin{array}{r} 812 \\ + 609 \\ \hline \end{array}$
No     543	Yes    1564	Yes    1204	No     840	Yes    1421

$\begin{array}{r} 220 \\ + 221 \\ \hline \end{array}$	$\begin{array}{r} 751 \\ + 876 \\ \hline \end{array}$	$\begin{array}{r} 577 \\ + 421 \\ \hline \end{array}$	$\begin{array}{r} 959 \\ + 493 \\ \hline \end{array}$	$\begin{array}{r} 385 \\ + 964 \\ \hline \end{array}$
No     441	Yes    1627	Yes    998	Yes    1452	Yes    1349

$\begin{array}{r} 466 \\ + 291 \\ \hline \end{array}$	$\begin{array}{r} 723 \\ + 977 \\ \hline \end{array}$	$\begin{array}{r} 617 \\ + 335 \\ \hline \end{array}$	$\begin{array}{r} 146 \\ + 618 \\ \hline \end{array}$
No     757	Yes    1700	No     952	No     764

$\begin{array}{r} 593 \\ + 251 \\ \hline \end{array}$	$\begin{array}{r} 996 \\ + 133 \\ \hline \end{array}$
No     844	Yes    1129

$\begin{array}{r} 921 \\ + 428 \\ \hline \end{array}$	$\begin{array}{r} 999 \\ + 779 \\ \hline \end{array}$
Yes    1349	Yes    1778

$\begin{array}{r} 407 \\ + 410 \\ \hline \end{array}$	$\begin{array}{r} 406 \\ + 665 \\ \hline \end{array}$
No     817	Yes    1071

How many  
Easter eggs go  
in the basket?

Answer:

12
----

Happy Easter from [www.math-drills.com](http://www.math-drills.com)

## ***Egg Symmetry***

*Put a mirror on the mirror line and draw the reflective symmetry to finish decorating these Easter eggs.*

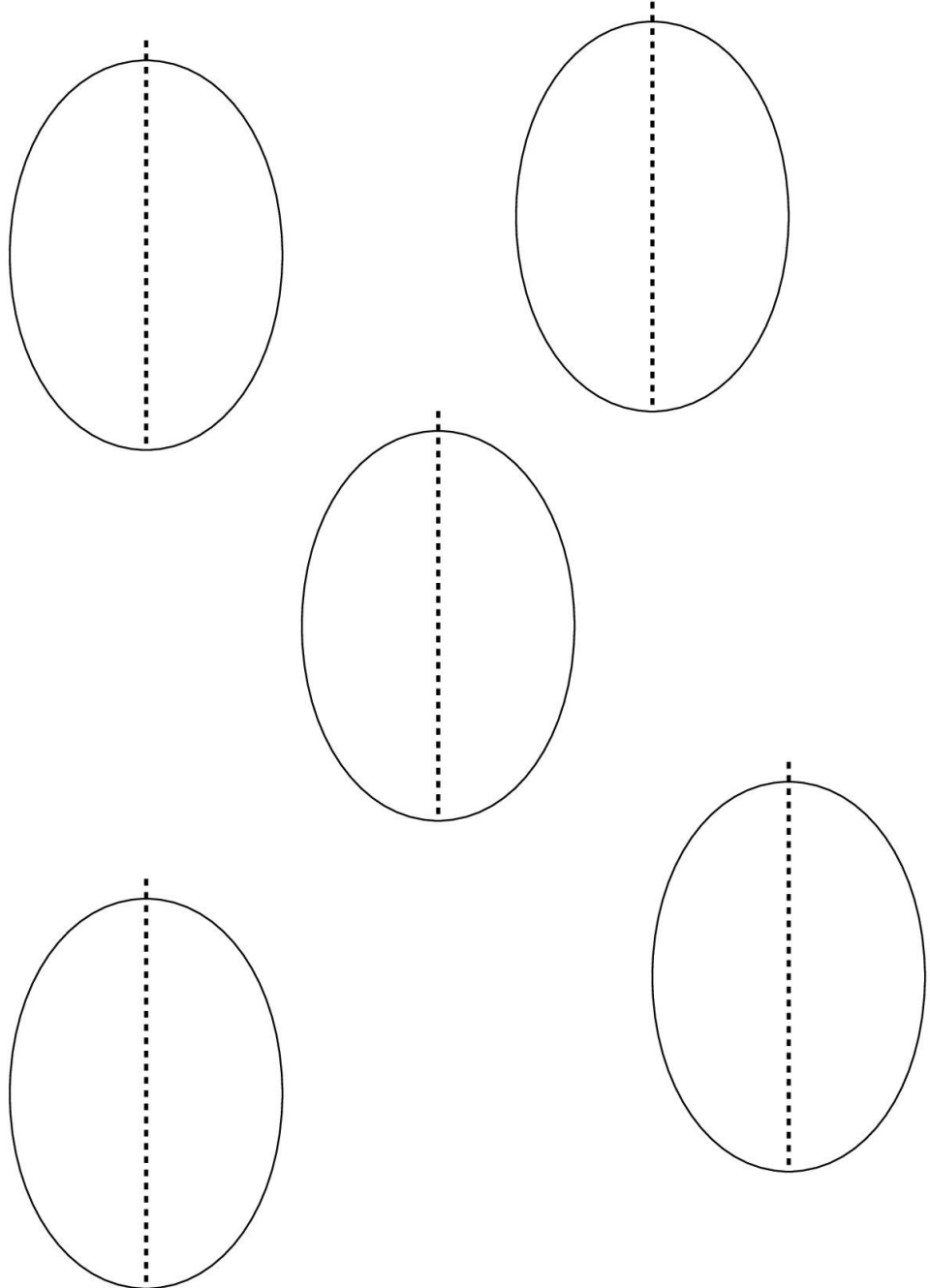

# How Many Bunnies Can You Count?

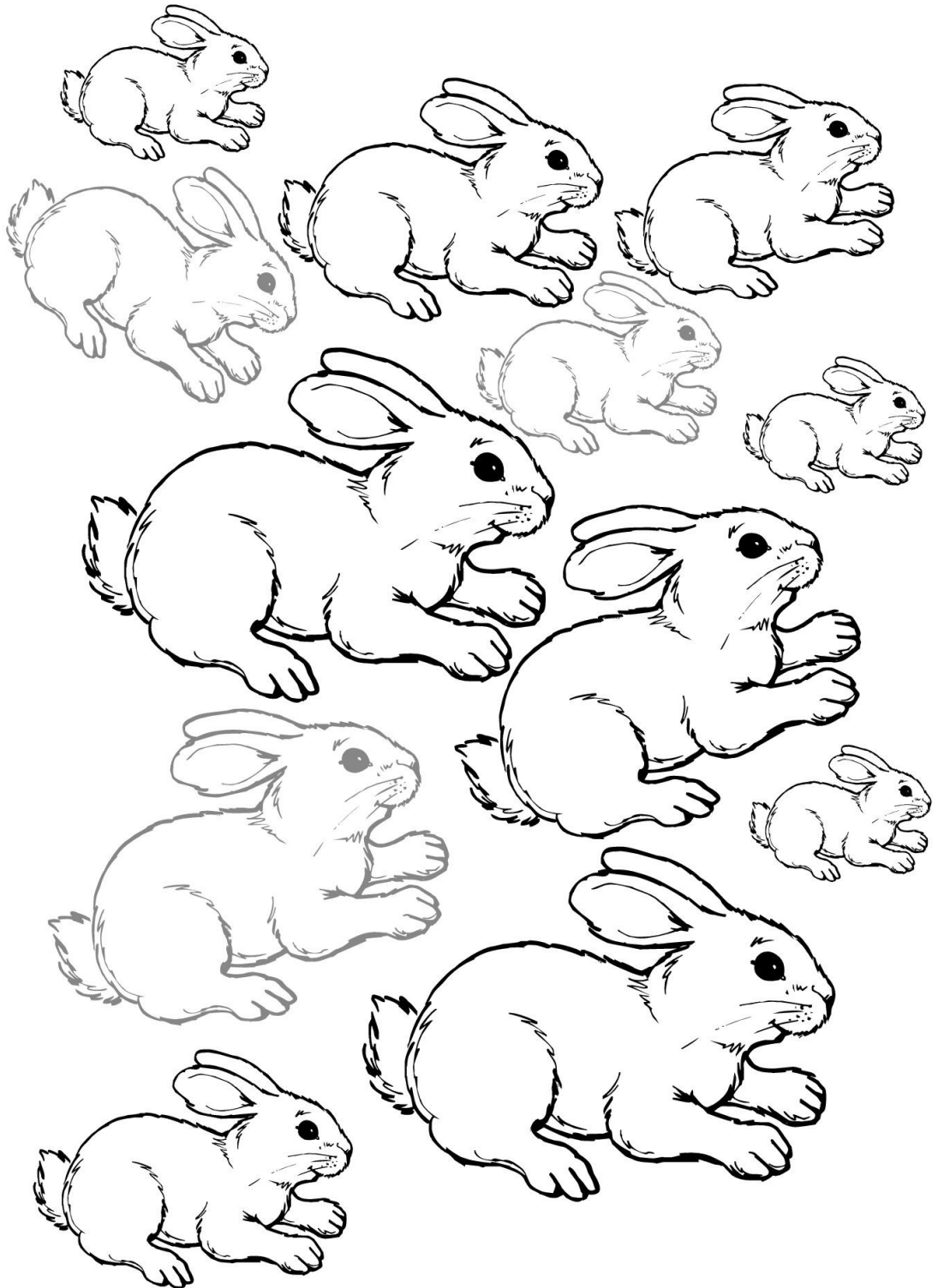

[www.ActivityVillage.co.uk](http://www.ActivityVillage.co.uk) - Keeping Kids Busy

# How Many Eggs

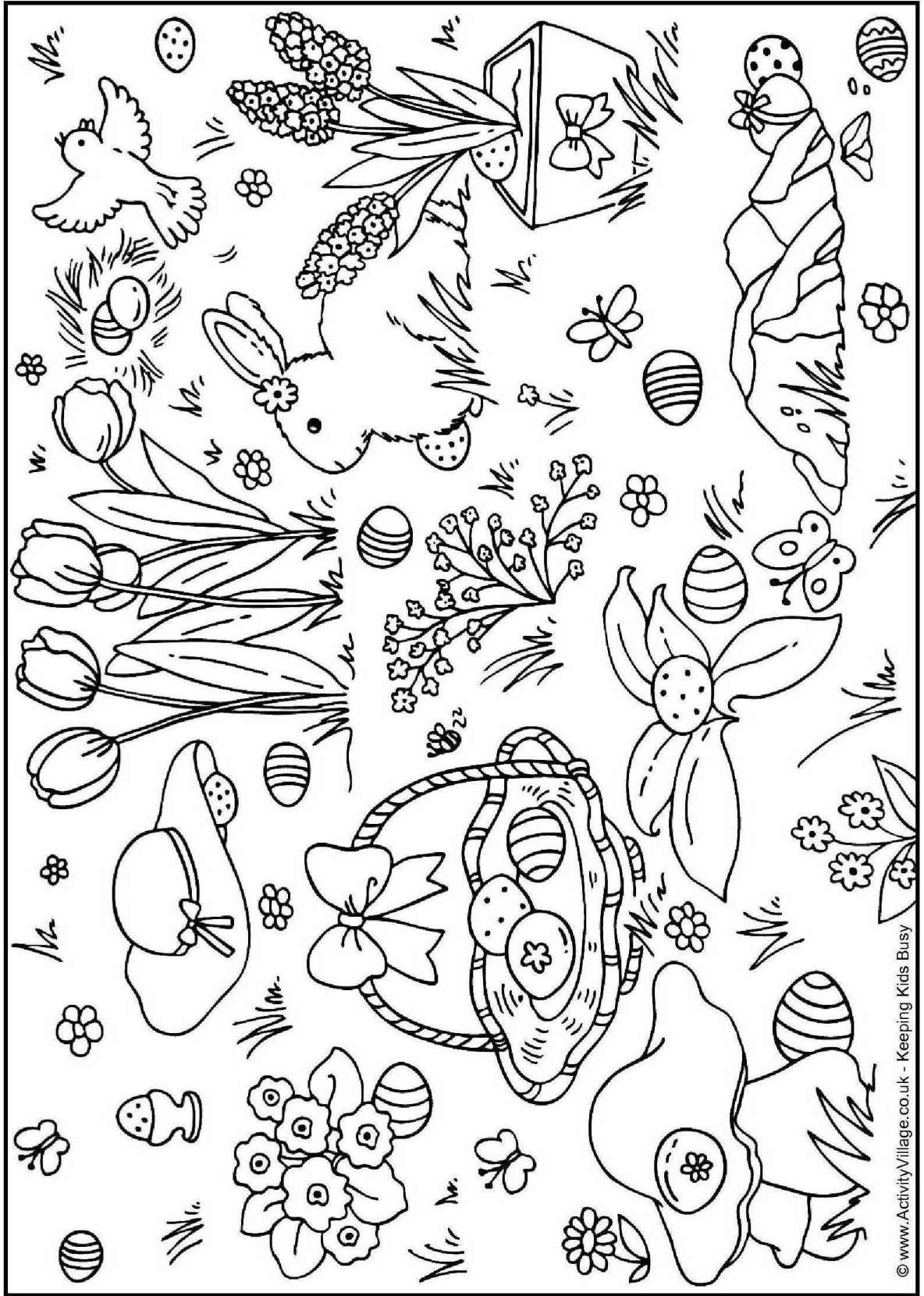

© www.ActivityVillage.co.uk - Keeping Kids Busy

# How Many Eggs?

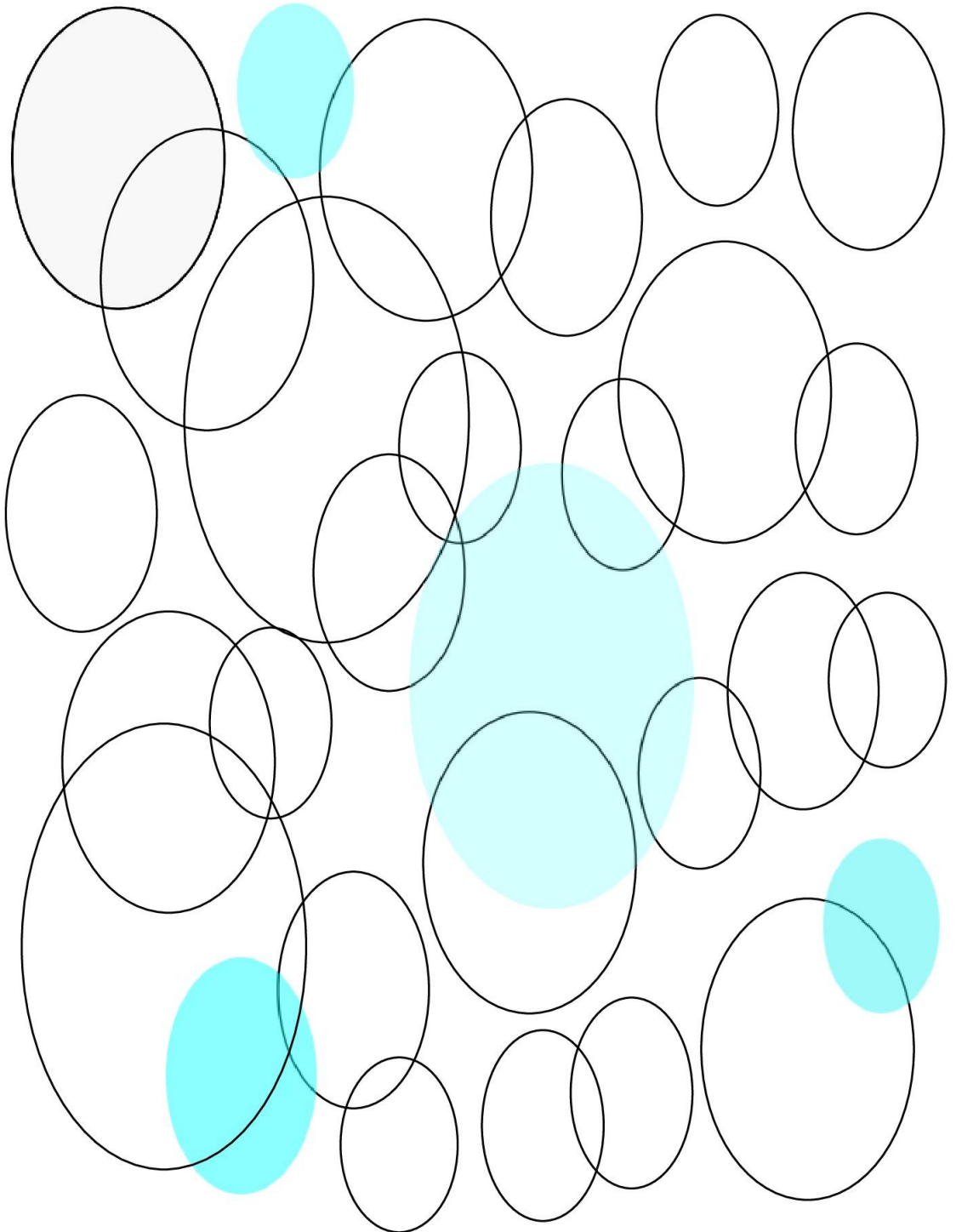

[www.ActivityVillage.co.uk](http://www.ActivityVillage.co.uk) - Keeping Kids Busy



*Matching Easter Egg Shapes.*

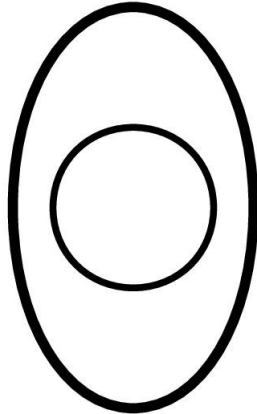
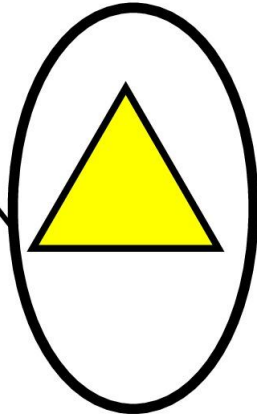
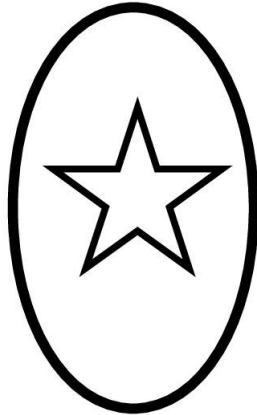
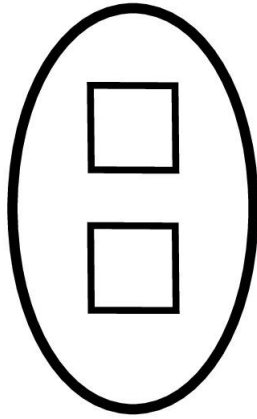
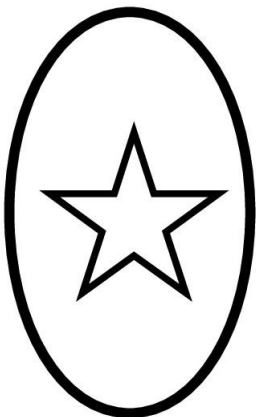
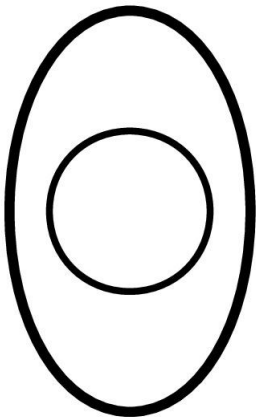
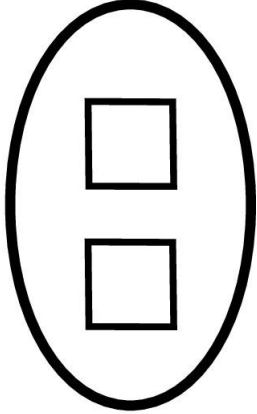
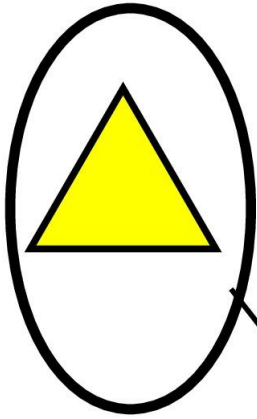

*Join matching eggs with a line and colour their shapes the same colour.*

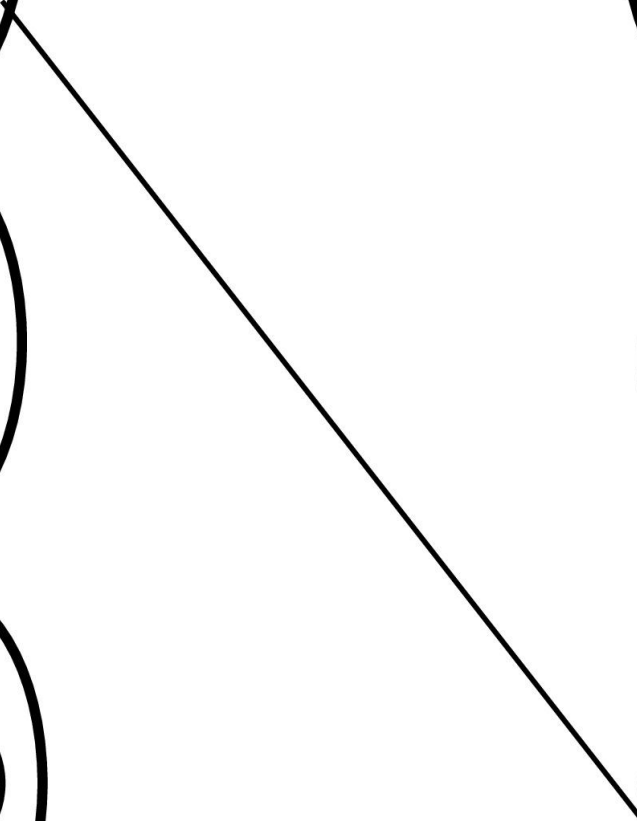

## EASTER MATH

How many Easter bunnies are there? \_\_\_\_\_

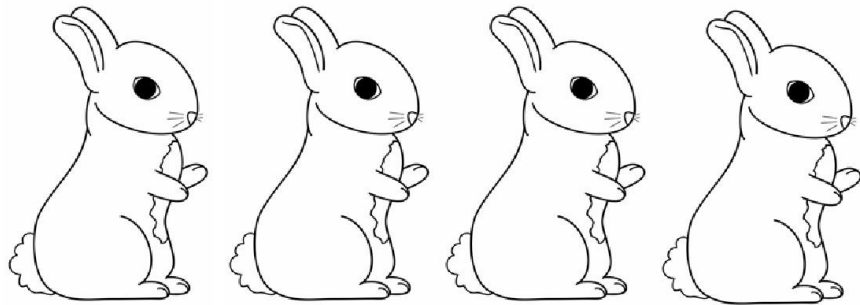

Color the bunnies.

How many Easter baskets are there? \_\_\_\_\_

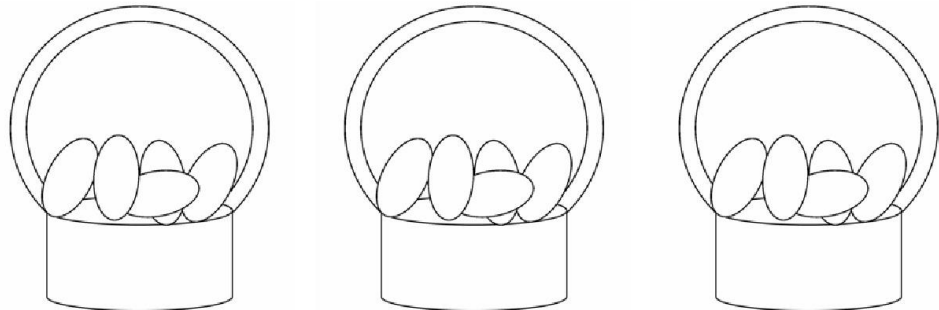





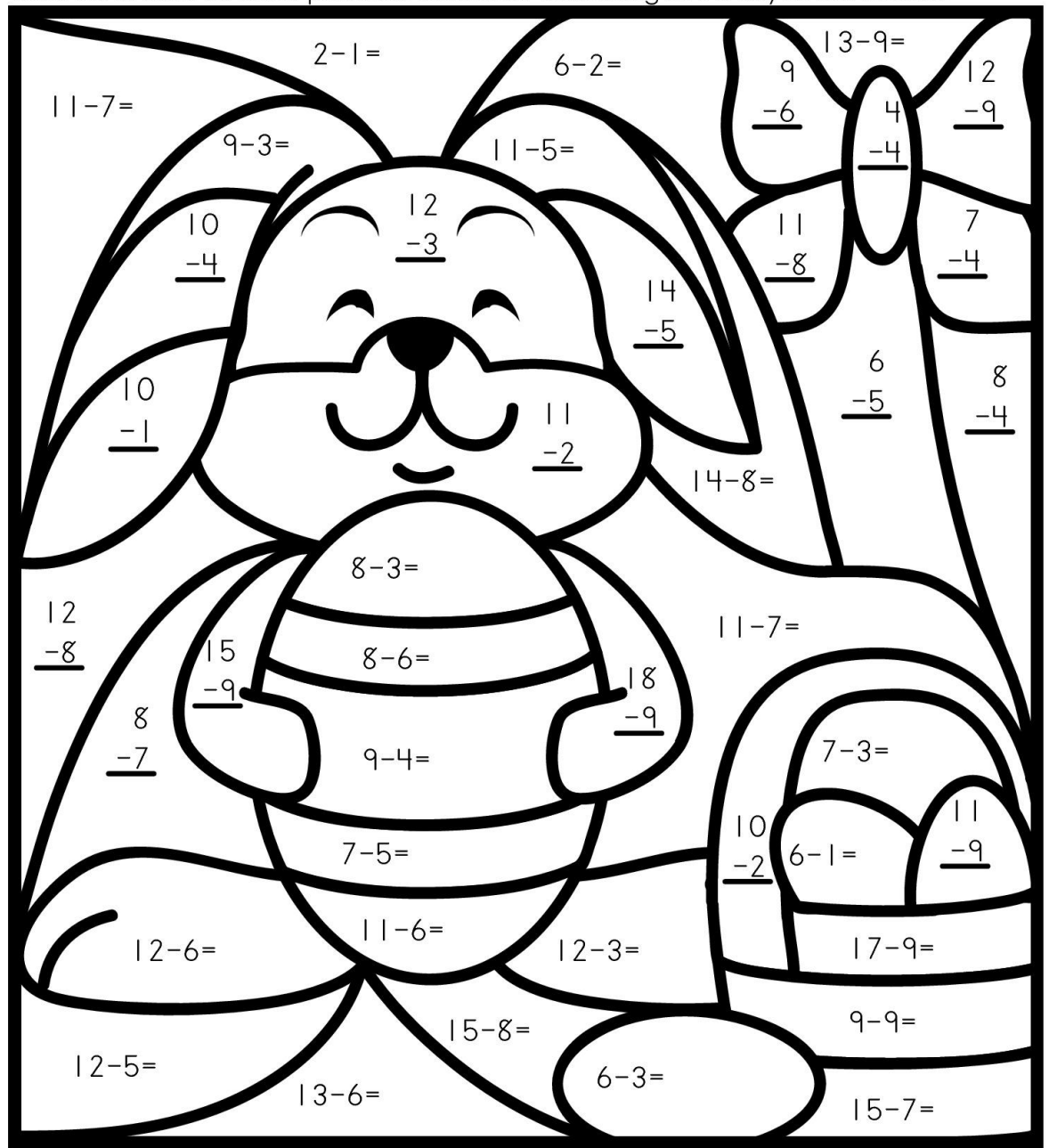

Color the baskets.

Name: \_\_\_\_\_

Write the answer for each problem. Then color according to the key at the bottom.



-  0, 8
-  6, 9
-  3
-  2

-  7
-  1, 4
-  5





Name \_\_\_\_\_ Date \_\_\_\_\_

### The Easter Bunny Gets Ready! Picture Graph

Read the picture graph and answer the questions.

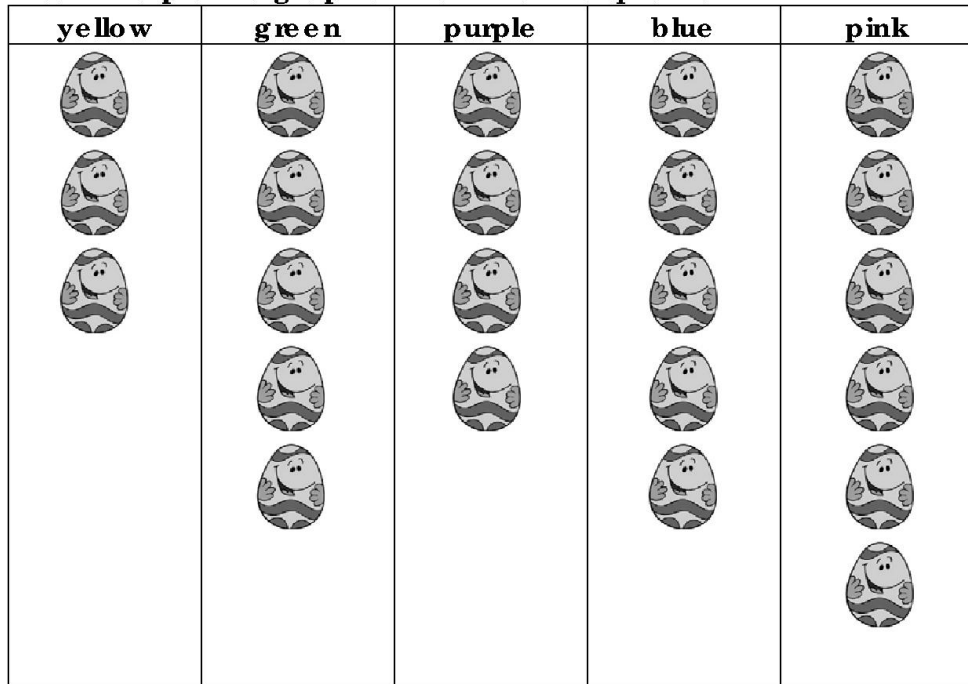

Each picture = 50 eggs dyed.

Answer the questions.

1. The Easter Bunny dyed \_\_\_\_\_ eggs yellow.
2. The Easter Bunny dyed \_\_\_\_\_ eggs green.
3. The Easter Bunny dyed \_\_\_\_\_ eggs purple.
4. The Easter Bunny dyed \_\_\_\_\_ eggs blue.
5. The Easter Bunny dyed \_\_\_\_\_ eggs pink.
6. How many more eggs were dyed pink than were dyed blue? \_\_\_\_\_
7. The Easter Bunny dyed the least number of eggs \_\_\_\_\_

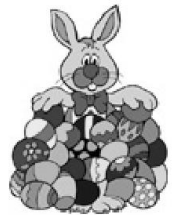

## THE EGG HUNT

**READ AND ANSWER THE FOLLOWING QUESTIONS  
USING THE PICTURE GRAPH BELOW.**

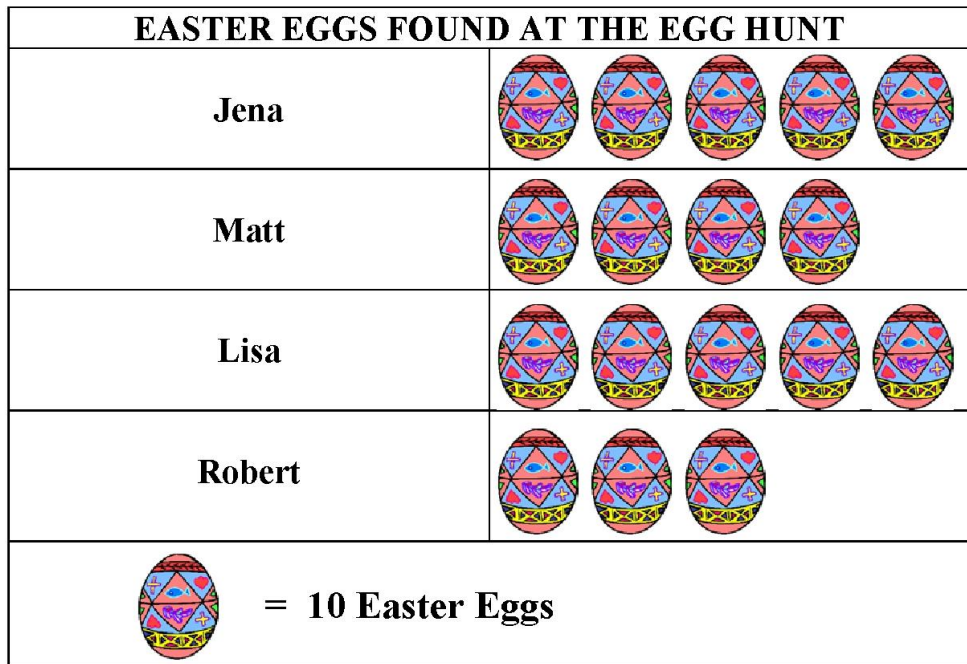

**ANSWER THE QUESTIONS:**

1. How many eggs did Matt find at the egg hunt? \_\_\_\_\_
2. Which two people found the same number of eggs?  
\_\_\_\_\_ and \_\_\_\_\_
3. How many eggs did Robert and Matt find in all? \_\_\_\_\_
4. How many more eggs did Jena find than Robert? \_\_\_\_\_
5. Who found the least number of eggs? \_\_\_\_\_

NAME \_\_\_\_\_ DATE \_\_\_\_\_

## THE EGG HUNT ANSWERS

1. 40
2. Jena and Lisa
3. 70
4. 20
5. Robert



# Easter Bonnet Parade

Can you match up the Easter Bonnets and find the odd one out?

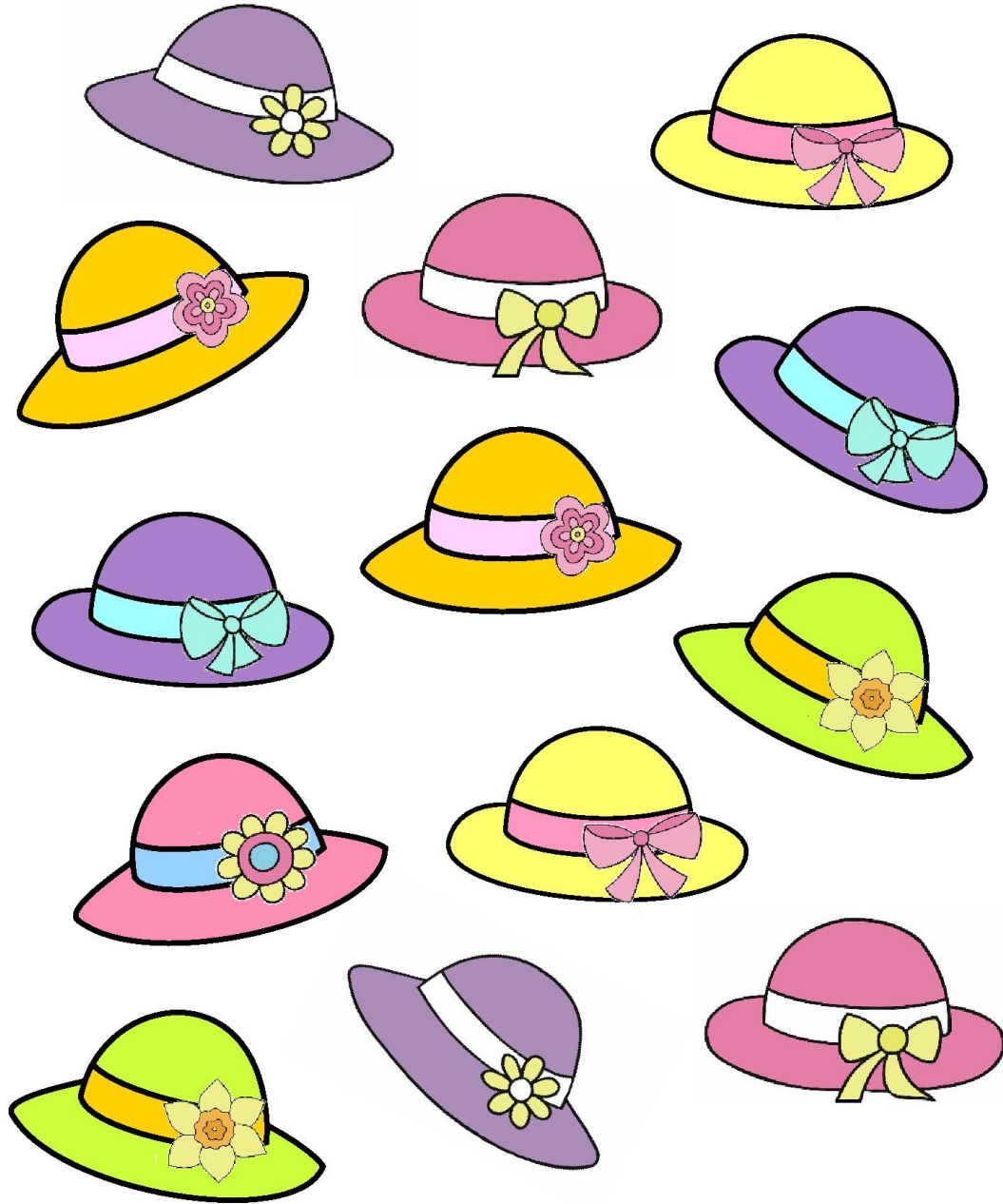

Copyright © www.ActivityVillage.co.uk - Keeping Kids Busy

Name \_\_\_\_\_

Colour the eggs



- colour 11 red
- colour 12 orange
- colour 13 green
- colour 15 blue

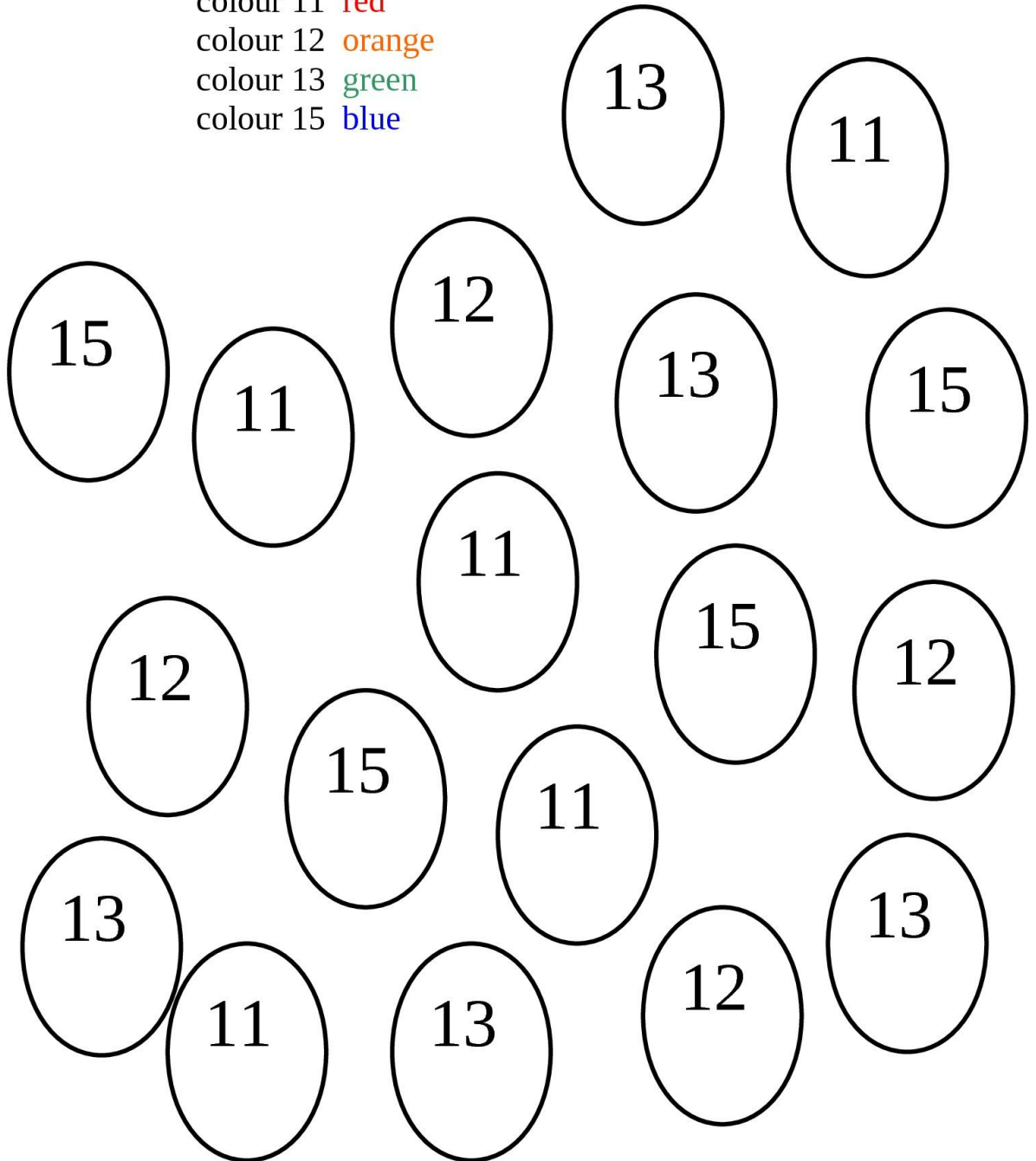

# Easter Maze

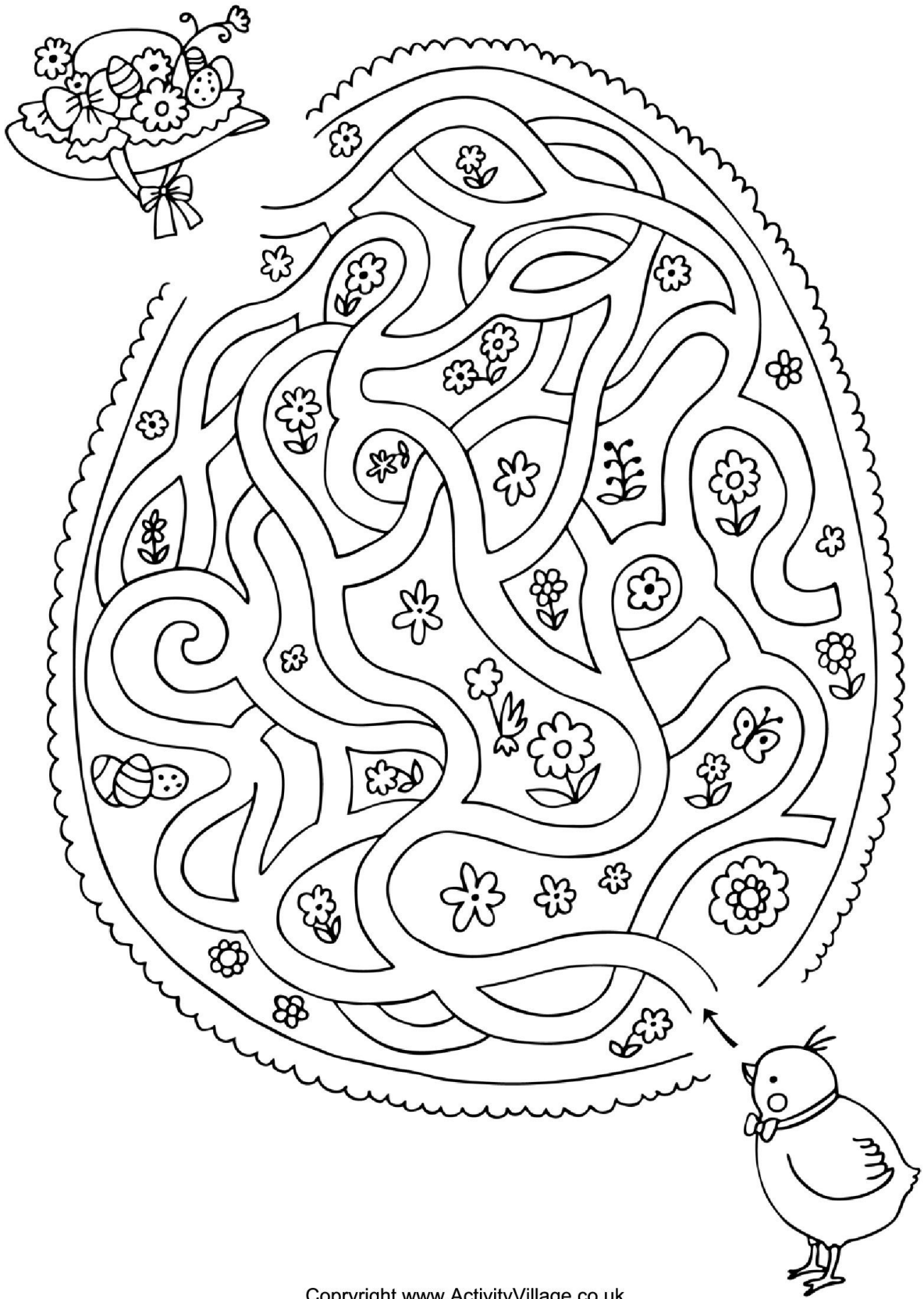

Copyright [www.ActivityVillage.co.uk](http://www.ActivityVillage.co.uk)

---

## EASTER MAZE - (A)

---

Instructions: Help Jim find the Easter Eggs that are multiples of 2. See if you can find his eggs in the maze.

$$\begin{array}{r} 2 \\ + 7 \\ \hline \end{array}$$

$$\begin{array}{r} 5 \\ - 0 \\ \hline \end{array}$$

$$\begin{array}{r} 9 \\ \div 3 \\ \hline \end{array}$$

$$\begin{array}{r} 4 \\ + 1 \\ \hline \end{array}$$

$$\begin{array}{r} 1 \\ + 1 \\ \hline \end{array}$$

$$\begin{array}{r} 3 \\ \times 3 \\ \hline \end{array}$$

$$\begin{array}{r} 2 \\ \times 2 \\ \hline \end{array}$$

$$\begin{array}{r} 4 \\ \times 2 \\ \hline \end{array}$$

$$\begin{array}{r} 3 \\ + 3 \\ \hline \end{array}$$

$$\begin{array}{r} 6 \\ \div 2 \\ \hline \end{array}$$

$$\begin{array}{r} 8 \\ + 1 \\ \hline \end{array}$$

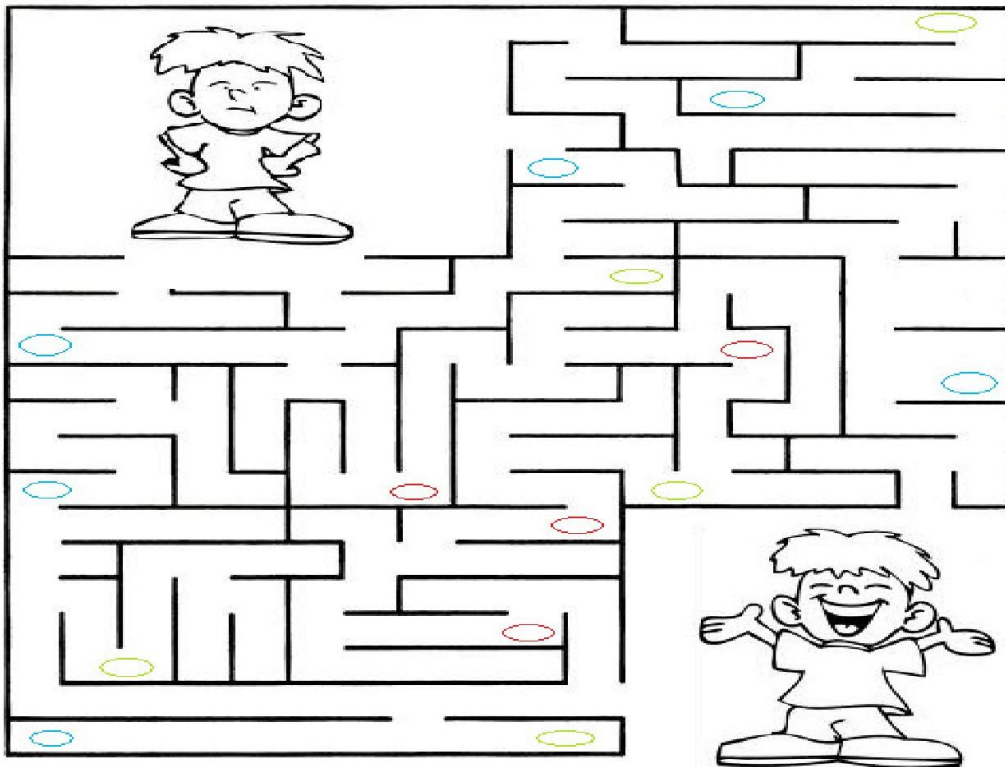

Total no. of Jim's eggs:

---

MATH-DRILLS.COM MATH-DRILLS.COM MATH-DRILLS.COM MATH-DRILLS.COM MATH-DRILLS.COM

---

## EASTER MAZE - (A) Answers

Instructions: Help Jim find the Easter Eggs that are multiples of 2. See if you can find his eggs in the maze.

$$\begin{array}{r} 2 \\ + 7 \\ \hline 9 \end{array}$$

$$\begin{array}{r} 5 \\ - 0 \\ \hline 5 \end{array}$$

$$\begin{array}{r} 9 \\ \div 3 \\ \hline 3 \end{array}$$

$$\begin{array}{r} 4 \\ + 1 \\ \hline 5 \end{array}$$

$$\begin{array}{r} 1 \\ + 1 \\ \hline 2 \end{array}$$

$$\begin{array}{r} 3 \\ \times 3 \\ \hline 9 \end{array}$$

$$\begin{array}{r} 2 \\ \times 2 \\ \hline 4 \end{array}$$

$$\begin{array}{r} 4 \\ \times 2 \\ \hline 8 \end{array}$$

$$\begin{array}{r} 3 \\ + 3 \\ \hline 6 \end{array}$$

$$\begin{array}{r} 6 \\ \div 2 \\ \hline 3 \end{array}$$

$$\begin{array}{r} 8 \\ + 1 \\ \hline 9 \end{array}$$

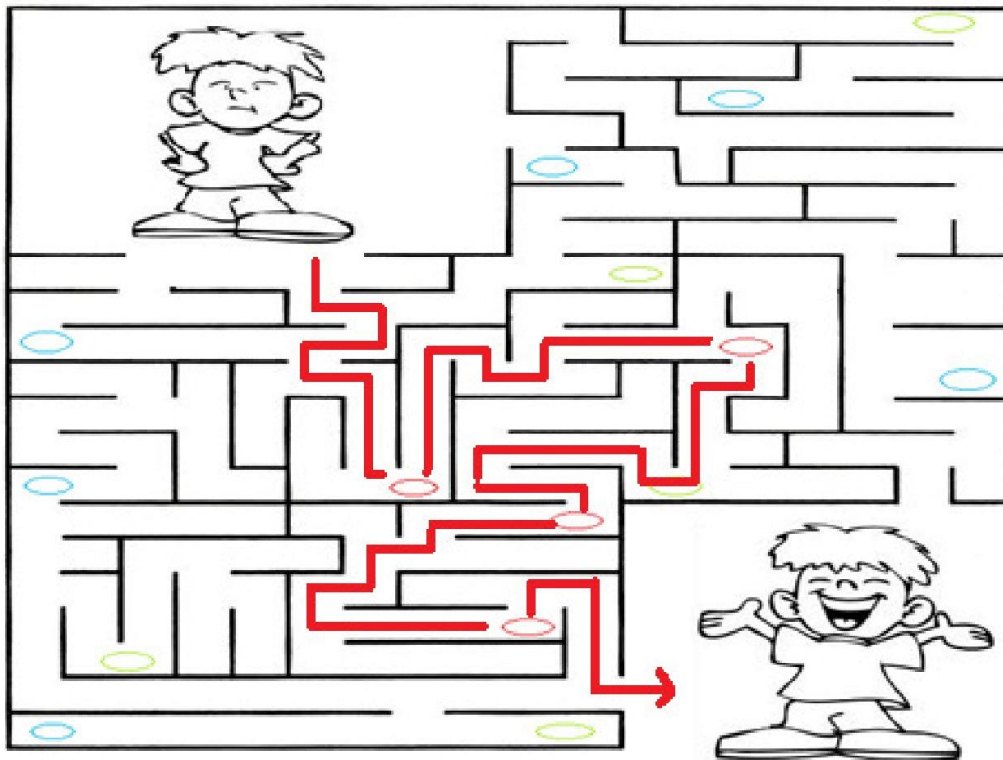

Total no. of Jim's eggs: 4

MATH-DRILLS.COM MATH-DRILLS.COM MATH-DRILLS.COM MATH-DRILLS.COM MATH-DRILLS.COM

Can you help the chick find his friend?

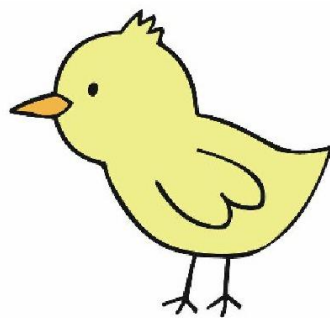
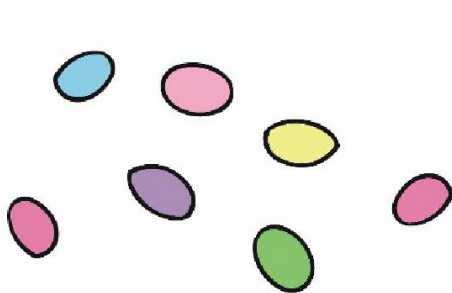
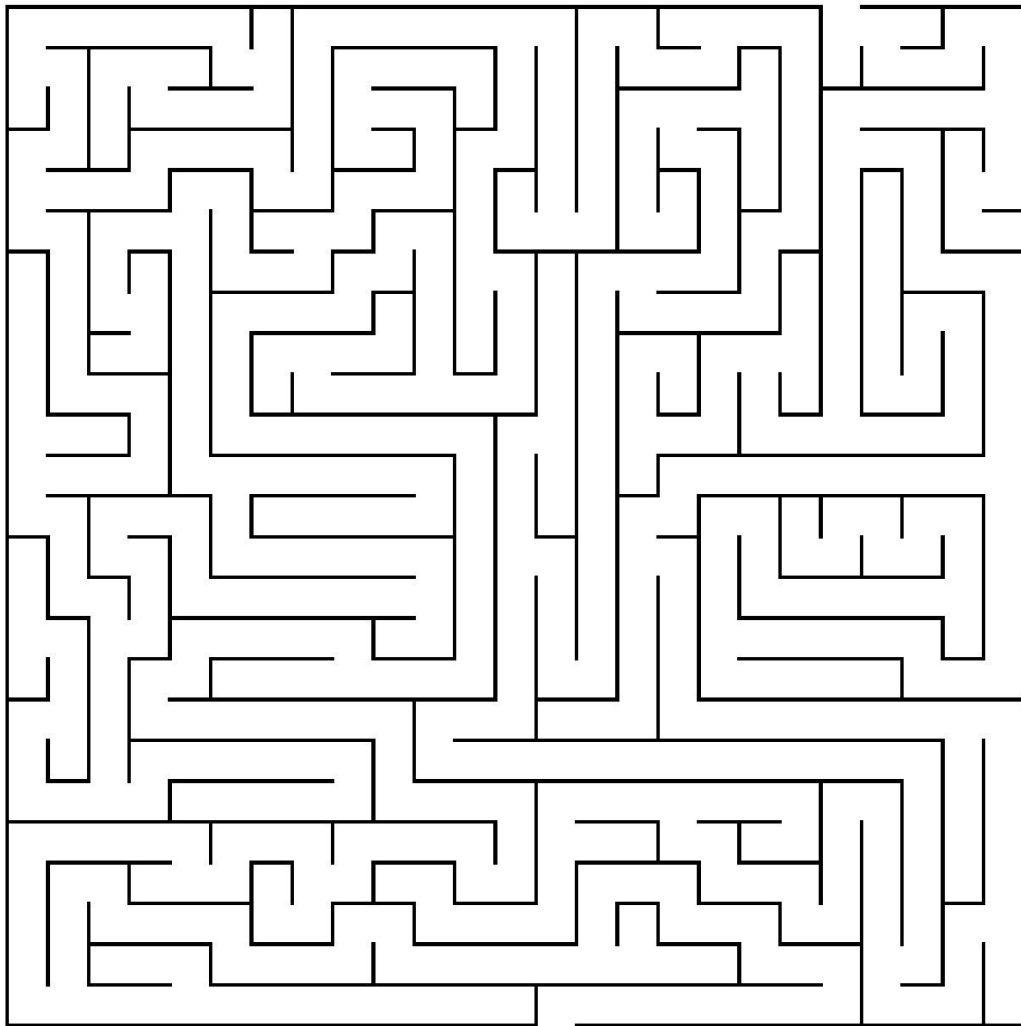
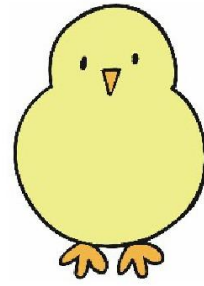

Can you help the Easter Bunny find the eggs?

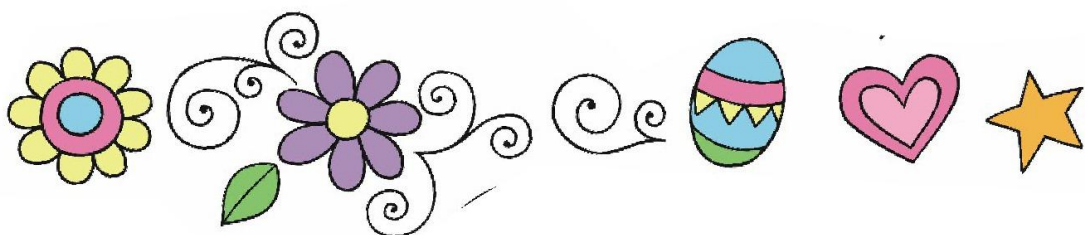
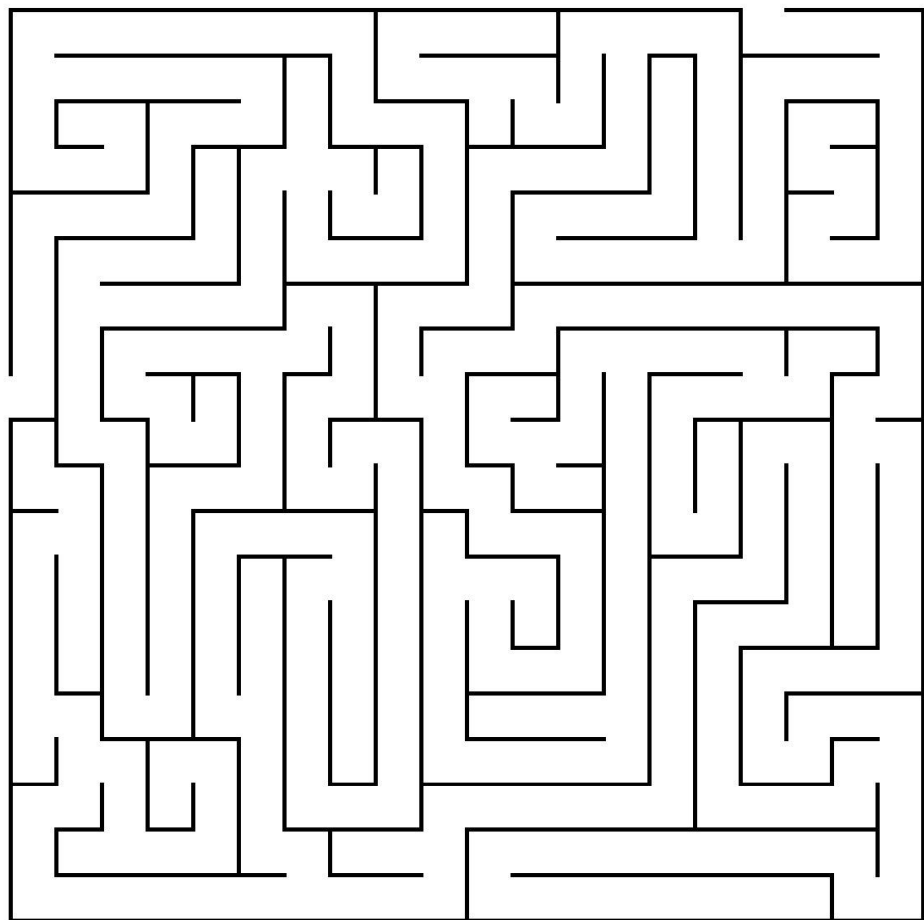
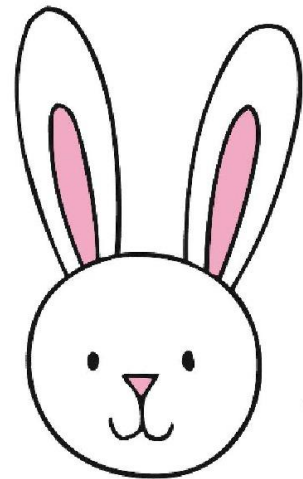

Copyright © www.ActivityVillage.co.uk - Keeping Kids Busy

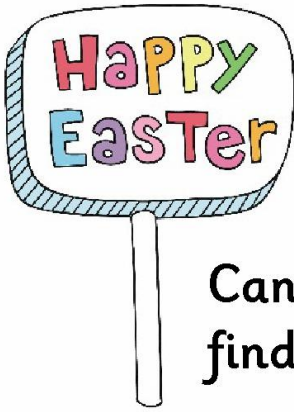

Can you help the bunny find the carrot?

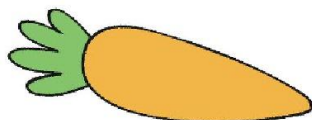
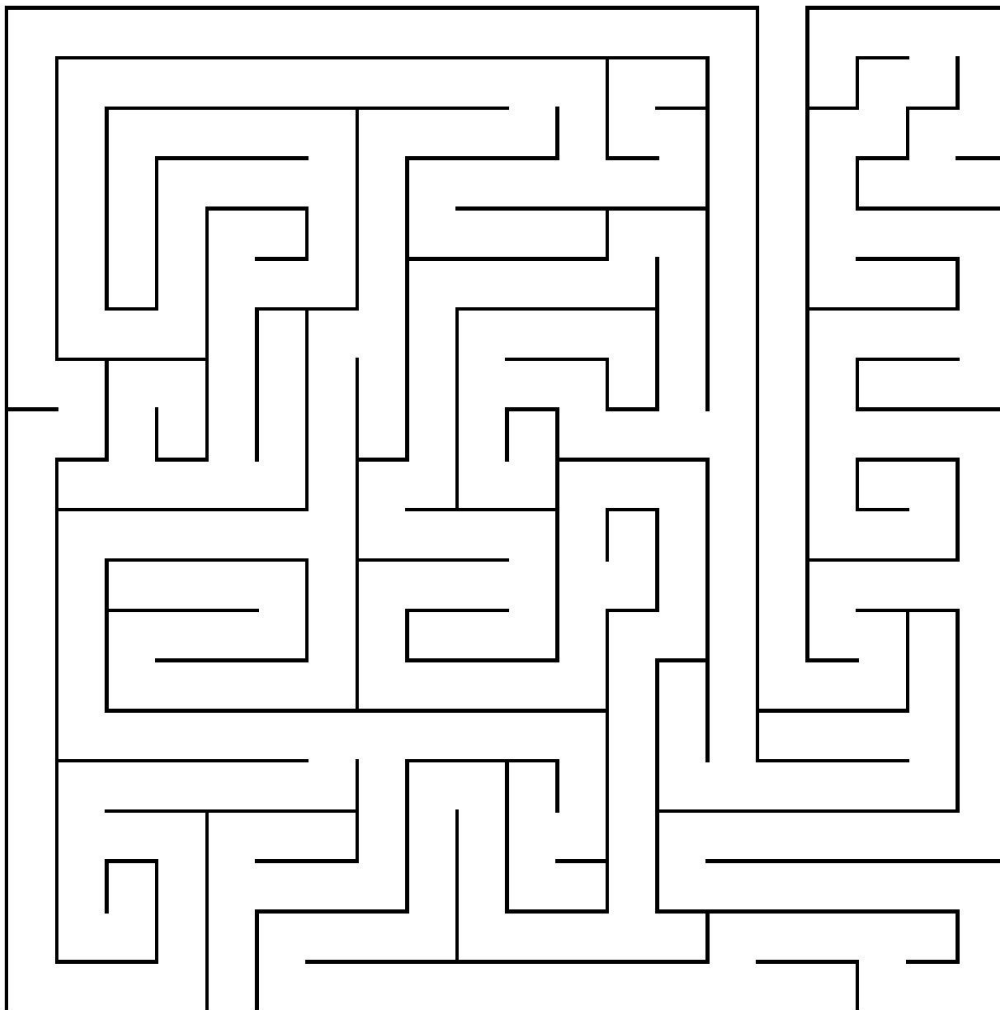
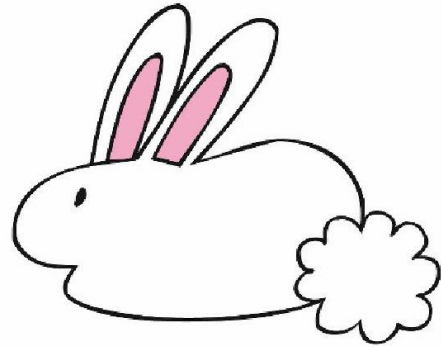

Copyright © [www.ActivityVillage.co.uk](http://www.ActivityVillage.co.uk) - Keeping Kids Busy



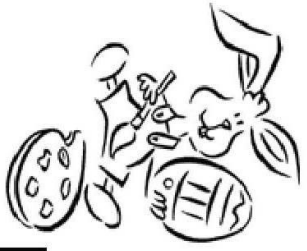

Help the bunny  
paint eggs.

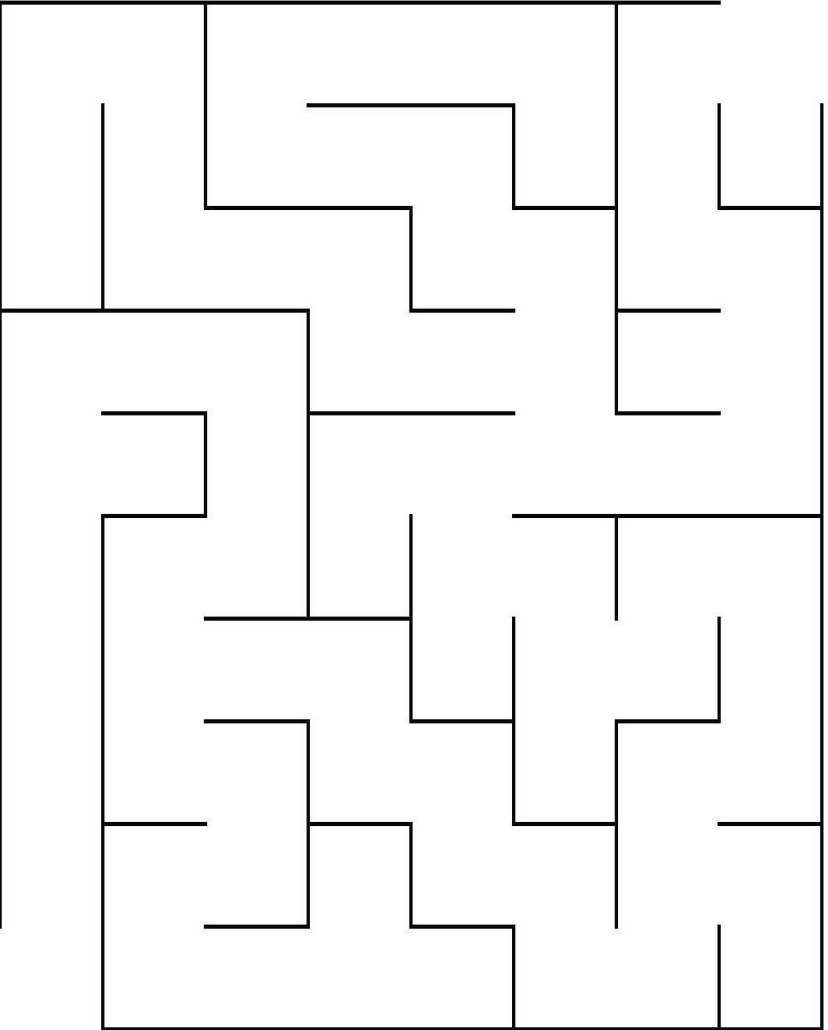

# Easter Puzzle

Can you help these friends find each other on the Easter Egg Hunt?

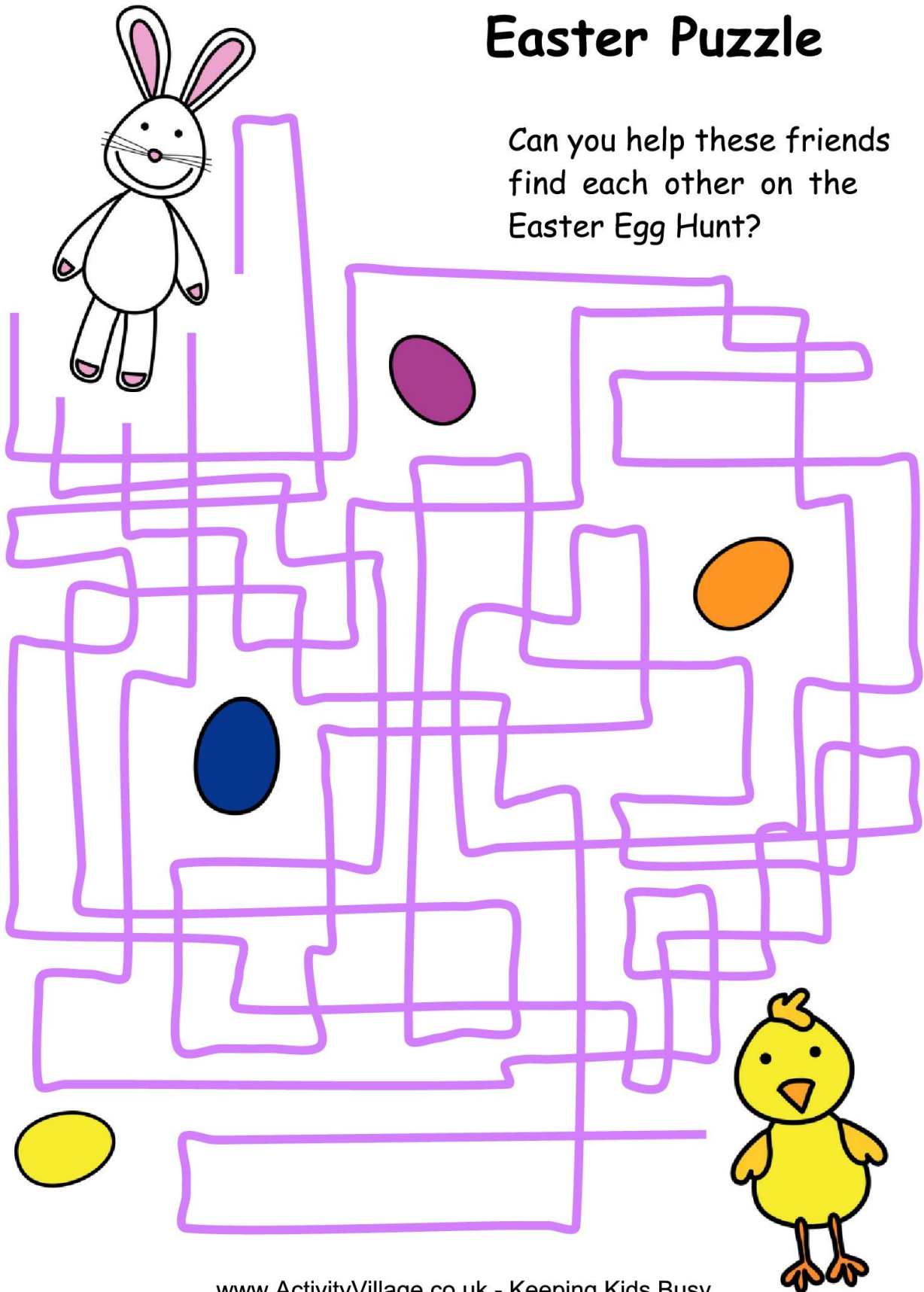

[www.ActivityVillage.co.uk](http://www.ActivityVillage.co.uk) - Keeping Kids Busy

# Easter Wishes in Different Languages

French	Joyeuses Pâques
German	Frohe Ostern
Italian	Buona Pasqua
Spanish	¡Felices Pascuas!
Dutch	Vrolijk Pasen
Polish	Szczęśliwej Wielkanocy!
Danish	God påske
Portuguese	Feliz Páscoa
Catalan	Bona Pasqua
Romanian	Paște Fericit
Croatian	Sretan Uskrs
Bulgarian	Честит Великден! Христос Воскресе! Воистина Воскресе!
Czech	Veselé Velikonoce!



